

HV610 Series Frequency Inverter User Manual

HNC Electric Limited

Introduction

First of all, thank you for choosing HV610 series inverter developed and produced by HNC Electric Limited.

HV610 series inverter is a general purpose, stable and high performance current vector inverter. Whether VF control or open loop vector/close-loop vector control operation, it has reached the industry's leading control level. At the same time, it has random PWM control technology beyond its peers. It can run normally in severe environments such as power grid fluctuation, high temperature, high humidity and concentrated dust, and has extremely high reliability.

Besides excellent performance and reliability, HV610 is also more powerful. Simple PLC, built-in PID, multi-stage speed, high-speed pulse, communication and other operation modes can also realize regular operation and switch operation between the two motors. In addition to the standard RS485 interface, it also supports two sets of PID parameter switching, parameter one-key recovery and user parameter backup.

HV610 series frequency inverters are divided into two types of G/P according to their uses, and support G/P integration it can be used to drive various kinds of automatic production equipment such as fans, water pumps, textile, paper drawing, machine tools, packaging, food, etc.

Precautions

- This instruction manual introduces the functional characteristics and usage methods of this series of products in detail. In order to make good use of the product and ensure the personal safety of users, please read the instruction manual carefully before use. Please keep for future reference after reading.
- If there are still difficulties that cannot be solved during use, please contact our local distributors or directly contact the customer service center.
- As the Company's products will continue to improve, the information provided is subject to change without prior notice.

Precautions for safety

The safe operation of the product depends on proper transportation, installation, operation and maintenance. Please pay attention to safety tips before carrying out these tasks.

Safety symbol description

In this instruction manual, safety matters are divided into the following two categories:



When it is used incorrectly, it will cause danger and may lead to personal injury and death.

Danger



When it is used incorrectly, it will cause danger and may cause slight or moderate personal injury of equipment damage.

Caution

Table of contents

Chapter I Purchase inspection.....	5	F1 Group first motor parameters.....	67
1.1 Inspection items.....	5	F2 Group motor vector control parameters.....	69
1.2 Nameplate description.....	6	F3 Group V/F control parameters.....	70
1.3 Description of components of frequency inverter...	7	F4 Group output terminals.....	74
Chapter II Installation wiring.....	8	F5 Group input terminals.....	80
2.1 Mechanical installation.....	8	F6 Group start-stop control.....	92
2.1.1 Installation Conditions.....	8	F7 Group torque control.....	97
2.1.2 Installation Space.....	9	F8 Group auxiliary function.....	98
2.2 Electrical Installation.....	10	F9 Group failure and protection.....	104
2.2.1 Frequency inverter main circuit terminal description.....	10	FA Group process control PID function.....	109
2.2.2 Main circuit wiring method and wiring matters needing attention:.....	11	FB Group 2 motor parameters.....	114
2.2.3 Frequency inverter control loop terminal description.....	12	FC Group multi-segment instruction and simple PLC function.....	115
2.2.4 Standard wiring diagram of frequency inverter	15	FD Group communication parameters.....	120
2.2.5 Control circuit wiring mode.....	16	FE Group user-defined function code.....	120
Chapter III Process operation.....	19	FF Group control optimization parameters.....	120
3.1 Operation keyboard and display interface.....	19	E0 Group fault record.....	120
3.2 Indicator light indicates run.....	19	P2 Group AIAO correction.....	122
3.3 key function description.....	20	U0 Group monitoring parameter group.....	124
3.4 Methods of checking and modifying function codes	20	Chapter VI Abnormal diagnosis.....	129
3.5 Two quick search modes for function code parameters there.....	21	6.1 Fault alarm and countermeasures.....	129
3.6 Commissioning.....	21	6.2 Matters needing attention in commissioning:.....	132
3.7 Motor characteristic parameter setting and self - learning.....	21	6.3 F0.01 = 2 (V/F mode), common problem solving methods.....	133
Chapter IV Functional parameters.....	24	6.4 Fault analysis and countermeasures.....	133
4.1 Summary of basic functional parameters.....	24	Chapter VII Maintenance.....	137
4.2 Summary table of monitoring parameters.....	55	7.1 Maintenance and repair.....	137
Chapter V Description of parameters.....	57	7.1.1 Routine maintenance.....	137
F0 Group basic function group.....	57	7.1.2 Regular maintenance.....	138
		7.1.3 Replacement of vulnerable parts of frequency inverter.....	138
		7.2 Storage.....	139

Chapter VIII Peripheral equipment.....	140
8.1 Peripheral equipment and optional parts connection diagram.....	140
8.2 Functional description of peripheral equipment..	140
8.2.1 No fuse circuit breaker and contactor.....	141
8.2.2 AC input reactor.....	142
8.2.3 AC output reactor.....	142
8.2.4 Selection of energy consumption braking unit and braking resistance.....	143
8.2.5 External DC reactor.....	145
8.2.6 Radio noise filter.....	145
Chapter IX Quality Assurance.....	148
9.1 Quality commitment.....	148
Additional instructions.....	149
Appendix A Introduction of Communication.....	150
Appendix B Technical specification for HV610 series frequency inverters.....	161
Appendix I general purpose keyboard dimensions and mounting dimensions.....	163
Appendix II Plastic shell dimensions and mounting dimensions.....	164
Appendix III dimensions and mounting dimensions of sheet metal machines.....	165
List of dimensions and mounting dimensions.....	166
Appendix D HV610 series inverter specifications.....	169
Constant pressure control solution Case V0.1 for water pump and fan.....	172
1.1. Overview.....	172
2.1 Two types of pressure sensors for pump and fan control.....	172
3.1 Control wiring diagram.....	172
3.2 Setting parameters.....	172
4.1 The sleep wake-up function.....	173
Inquiry method of state parameters.....	174
Warranty Agreement.....	176

Chapter I Purchase inspection

	Danger
<ul style="list-style-type: none"> ● Do not install the frequency inverter if it is damaged, water intake, parts missing or damaged 	

	Caution
<ul style="list-style-type: none"> ● Handle with care and avoid falling shock. ● Do not use your hands to pull or touch any components of the machine to avoid short-circuit accidents or electrostatic damage 	

1.1 Inspection items

Although the Company's products have been strictly inspected before leaving the factory, due to transportation or unforeseen circumstances, please carefully inspect the products after purchase.

The items and methods that must be checked and confirmed are as follows:

Confirmation content	Confirmation method
Is it consistent with the goods ordered	Please confirm the nameplate on the side of the machine
Are there any parts broken or damaged	Check the overall appearance and check for damage during transportation
Are there any loose fastening parts such as screws	If necessary, use a screwdriver to check it
Instructions, certificates of conformity and other accessories	Operating instructions and corresponding accessories

If there is any bad situation or abnormality, please contact the agent or the Company's customer service center.

1.2 Nameplate description

- Nameplate data

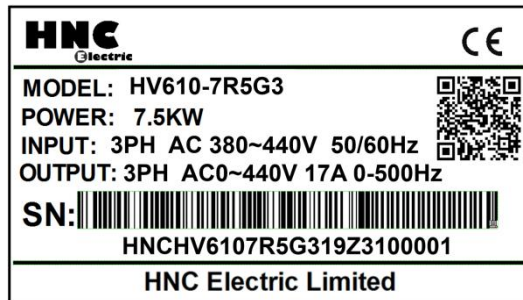

Description of frequency inverter model

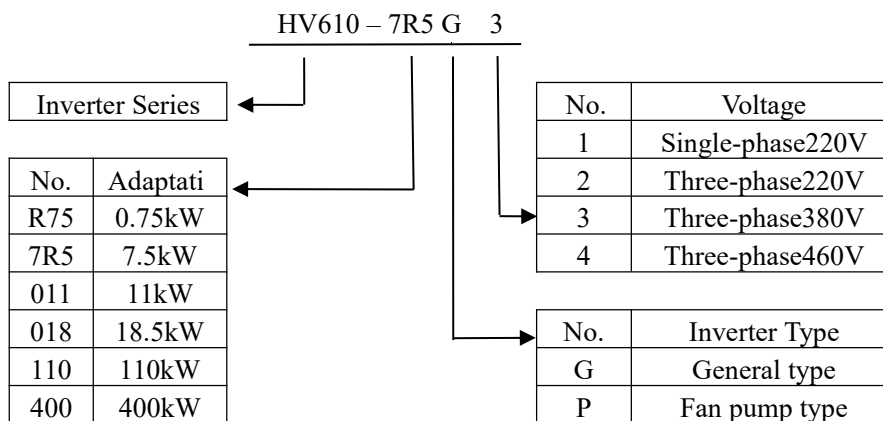

Note:

G1 input voltage range: Single-phase AC220V ± 15%

G2 input voltage range: Three-phase AC220V ± 15%

G3 input voltage range: Three-phase AC 380~440 (-15%~+10%)

G4 input voltage range: Three-phase AC 460~480 (-15%~+10%)

Note of DC reactor:

G1: No interface

G2: 18kw and below, no interface; 22kw~200kw, interface is optional, 220kw built-in DC reactor.

G3: 37kw and below, no interface; 45kw~400kw, interface is optional, 450kw and above built-in DC reactor.

G4: 37kw and below, no interface; 45kw~400kw, interface is optional, 450kw and above built-in DC reactor.

1.3 Description of components of frequency inverter

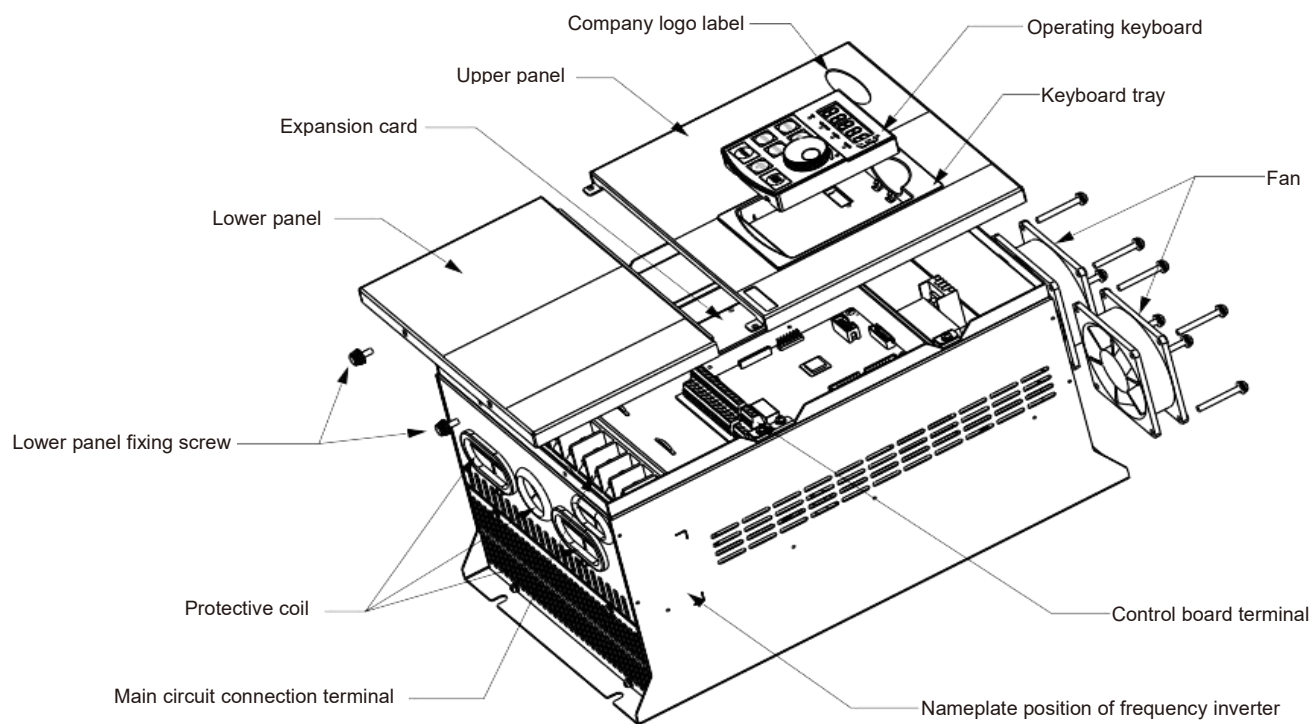

Take HV610-022G3 as an example

Chapter II Installation wiring

2.1 Mechanical installation



Danger

- Please install it on the refractory material board such as metal.
- Installed on flammable materials, there is a risk of fire.
- When two or more frequency inverters are installed in the same control cabinet please set up a cooling fan and keeps the air temperature at the air inlet below 40 °C.
- Due to overheating, fire and other accidents will occur.



Caution

- Please support the bottom of the machine body when carrying. Please use the machine with lifting rings. For machines that do not have rings, do not only take panels to prevent injury.

Please install the frequency inverter in the following application places and maintain the appropriate conditions.

2.1.1 Installation Conditions

- 1) It is the best to have a well ventilated room.
- 2) Ambient temperature - 30 °C ~ + 40 °C, bare machine with - 30 °C ~ 50 °C.
- 3) The humidity is less than 90 % RH, and there is no water splashing or dripping.
- 4) The installation foundation is firm and not easy to be vibrated, and its vibration is not more than 0.5g.
- 5) Avoid direct sunlight.
- 6) Avoid installing in places with corrosive and combustible gases in the air.
- 7) Avoid installing in places with dust, oil stain and polymetallic dust in the air.
- 8) Avoid installing in places with electromagnetic interference sources.
- 9) Below 1000 meters above sea level. High altitude areas should be reduced in use, or the ambient temperature should be reduced by 0.5 °C for every 100 meters above sea level.

2.1.2 Installation Space

The installation diagram of the frequency inverter is as follows:

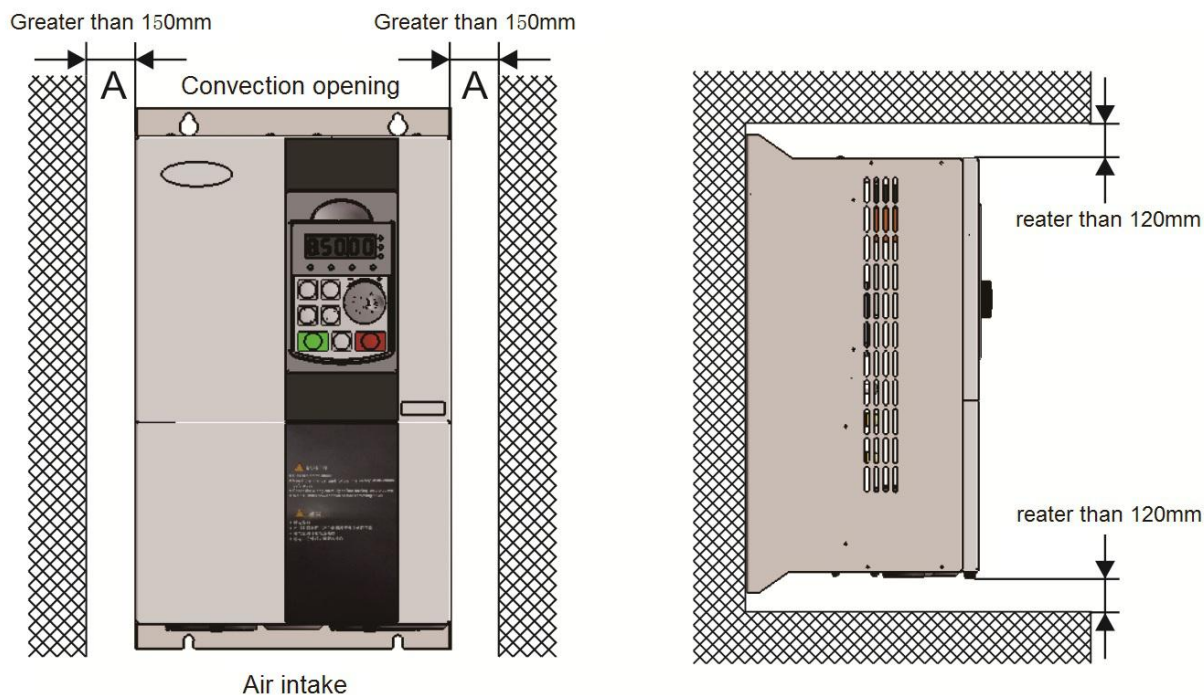

Monomer installation: the size of A is larger than 150 mm, because the upper and lower directions are air ducts, the space distance should be increased.

When installing up and down: when installing the frequency inverter up and down, please press the heat insulation baffle as shown in the figure on the right.

The mechanical installation needs to pay attention to the heat dissipation problem, so please pay attention to the following points:

- Please install the frequency inverter vertically so that heat can be dissipated upwards. If there are more frequency inverters in the cabinet, it is better to install them in parallel. For occasions requiring mounting up and down, please refer to the schematic diagram on the right side to install the heat insulation deflector.

- For applications with metal dust, it is recommended to install the radiator outside the cabinet. At this time, the space inside the fully sealed cabinet should be as large as possible.

- Mounting bracket must be flame retardant material

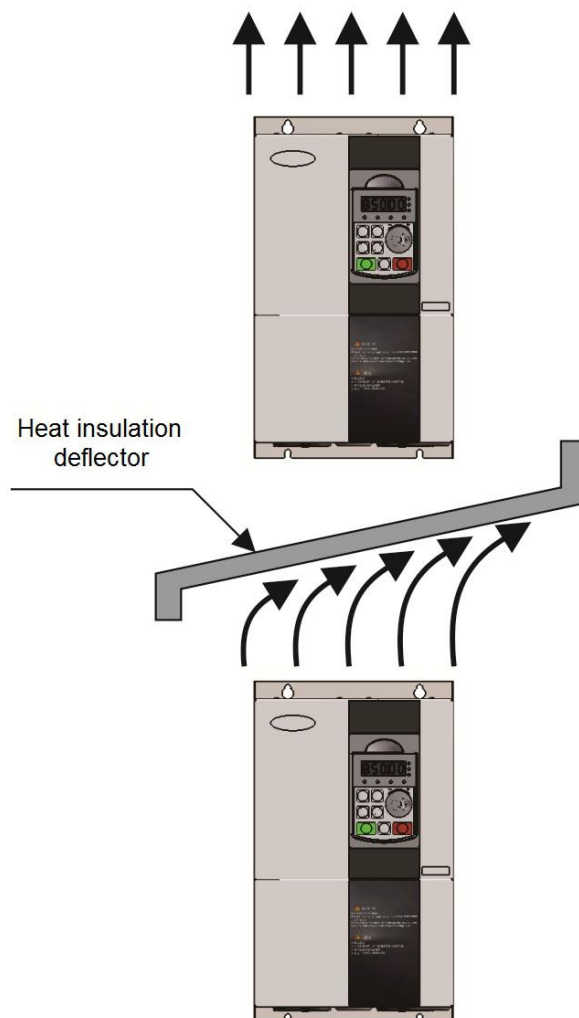

2.2 Electrical Installation



Danger

- Before wiring, please make sure that the input power supply is cut OFF to avoid electric shock and fire.
- To ensure safety, grounding terminals must be reliably grounded according to the specification requirements.
- Do not connect the input power supply to the U, V, and W terminals of the output by mistake.



Caution

- Please confirm whether the AC power supply is consistent with the rated input voltage of the frequency inverter
- Do not connect the electromagnetic switch and contactor to the frequency inverter input circuit.
- Before peripheral equipment is connected to the frequency inverter, it must be confirmed that its insulation to ground is in good condition.
- Do not conduct insulation withstand voltage test on the frequency inverter so as not to damage the devices inside the machine.

2.2.1 Frequency inverter main circuit terminal description

1) Main loop terminals below 22kw:



2) 30kw / 37kw frequency inverter main circuit terminal:

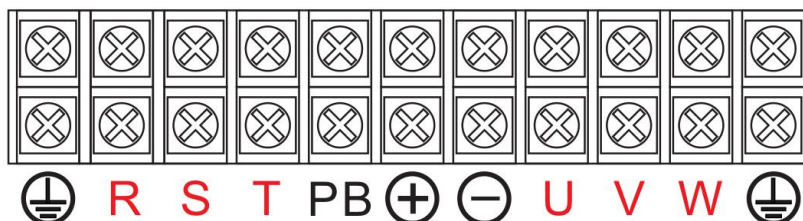

3) Main loop terminal of frequency inverter of 45kw and above:

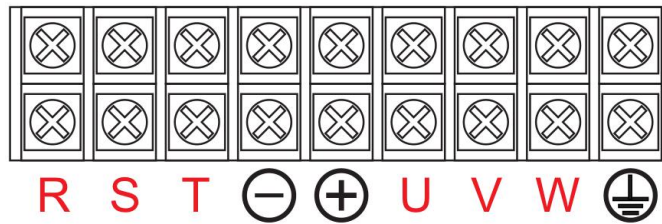

Description of main circuit terminal of three-phase frequency inverter

Terminal marking	Name	Description
R,S,T	Three-phase power supply input terminal	Connection point for AC input three-phase power supply
⊖,⊕	Negative and positive terminals of DC bus	Common DC bus input point
⊕,PB	Brake resistor connection terminal	Brake resistance connection point
⊕,P+	DC reactor connection terminal	
U,V,W	frequency inverter output terminal	Connecting three-phase motor
⊥	Earth terminal	Earth terminal

2.2.2 Main circuit wiring method and wiring matters needing attention:

- Input power supply R, S, T: input side wiring of frequency inverter, no phase sequence requirements.
- Terminals ⊕ and ⊖ DC bus: please note that there is still a high residual voltage in the DC bus just after the power failure, so it must wait at least 15 minutes later, or confirm that the voltage is less than 36 V before touching, otherwise there is danger of electric shock.
- When selecting an external brake unit, pay attention to the positive and negative polarity, which cannot be reversed, otherwise, the frequency inverter will be damaged or even damaged by fire. In order to prevent stray inductance from affecting the braking effect, the wiring length of the braking unit should not exceed 5m. Twisted pair or tight double wire should be used for parallel preparation, and non-inductive resistance should also be used for braking resistance.
- Brake resistance connection terminals ⊕, PB: 22kW G type machines and the following specifications are models with built-in brake function. The wiring precautions for the brake resistance are the same as those for the output side U, V, and W: the frequency inverter capacitors or surge absorbers cannot be connected to the output side of the frequency inverter, otherwise, the frequency inverter will often be protected or even damaged. When the motor cable is too long, due to the influence of the distributed capacitance, it is easy to generate electrical resonance, thus causing the motor insulation to be damaged or causing a large leakage current to cause over current protection of the frequency inverter. When the length of the motor cable is greater than 100 m, an AC output reactor must be installed.
- Earthling terminal ⊥: the terminal must be reliably grounded, and the resistance value of grounding wire must be less than 0.1Ω. Failure to do so will result in work of equipment is abnormal or even damaged Do not share the earthling terminal with the N terminal of the zero line of the power supply.
- See [2.2.4 inverter standard wiring diagram] for wiring method].
- Frequency inverter on/off operation should avoid frequent power-up and power-down operations (less than twice per minute) or direct start-up operations of the frequency inverter through contactors. Refer to the following table for air switch, contactor and conductor section.

2.2.3 Frequency inverter control loop terminal description

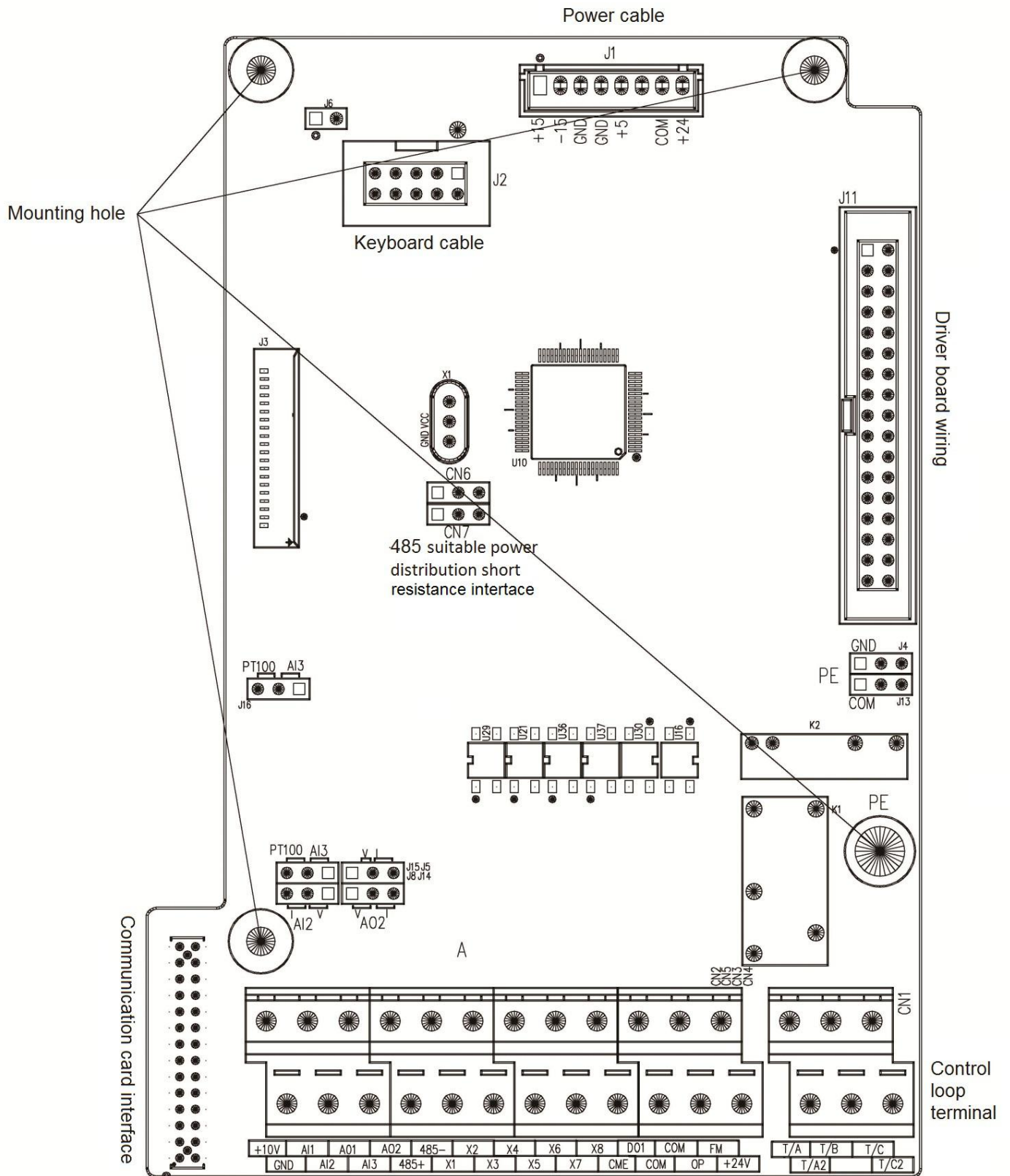

HV610 jumper description: and its function table

Jumper number	Description
J4	GND ground terminal
J5	AO1 output terminal selection - voltage / current
J14	AO2 output terminal selection - voltage / current
J13	COM ground terminal
J8	AI2 analog input terminal selection - voltage / current
J15 & J16	AI3 analog input terminal selection - temperature /AI, to be used in combination
CN6 & CN7	485 communication terminal resistance, need to be used in combination

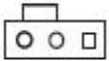
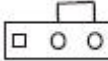
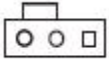
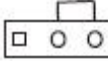
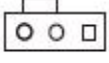
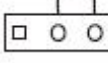
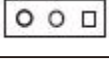
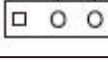
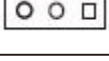
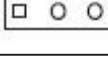
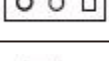
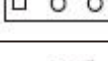
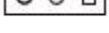
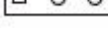
Jumper serial number	Jumper position	Functional Description	Jumper position	Functional Description
J4		0.1 u F is connected between GND and PE		-
J5		AO1 analog DC 0 ~ 10 v output		AO1 analog DC 0 ~ 20 m a output
J8		AI2 analog DC 4 m a ~ 20 m a		AI2 analog DC 0~ 10V
J13		0.1 u f between COM and PE		-
J14		AO2 analog 4 m A ~ 20m A output		AO2 analog DC 0~ 10 V output
J15 & J16		AI3 terminal for PT100 input		AI3 terminal is analog DC 0V~ 10 V
CN6 & CN7		Connect 485 communication terminal resistance		Terminal resistance not connected

Category	Terminal symbol	Terminal name	Functional Description
Power supply	+10V-GND	External connection + 10v power supply	External provide + 10v power supply the maximum output current is 10mA, which is generally used as the working power supply for external potentiometer and the resistance value of potentiometer ranges will be from 2.5k ~ 5kΩ
	+24V-COM	External connection + 24v power supply	External provide + 24v power supply, generally used as working power supply for digital input and output terminals and maximum output current for external sensor power supply: 200mA
	OP	External power input terminal	Select + 24V or OP connection through the short connector 1 on the control panel, and the factory defaults to + 24v connection. When X1 ~ X7 are driven by external signals, OP needs to be connected to external power supply.
Analog input	AI1-GND	Analog input terminal 1	1. Input voltage range: DC 0V ~ 10V 2. Input impedance: 22kΩ
	AI2-GND	Analog input terminal 2	1. Input range: DC 0V~10V/4mA~20mA, determined by the selection of AI2 jumper on the control panel. 2. Input impedance: 22kΩ for voltage input and 500Ω for current input.
	AI3-GND	Analog input terminal 3	1. Optical coupling isolation input can accept differential voltage input, current input, temperature detection resistance input 2. Input range: DC ±10V or ±(4~20mA), determined by the selection of AI3 jumper on the control panel.
Digital input	X1~X7	Digital input	1. Optical coupling isolation is compatible with bipolar input 2. Input impedance: 2.4kΩ 3. Voltage range during level input: 9V~30V
	X5	High-speed pulse input terminal	Besides the features of X1~X4, it can also be used as a high-speed pulse input channel. Highest input frequency: 100kHz; Voltage range: 9V~30V
Analog output	AO1-GND	Analog output 1	The AO1 jumper on the control board determines the voltage or current output. Output voltage range: 0V ~ 10V output current range: 0mA ~ 20mA
	AO2-GND	Analog output 2	The AO2 jumper on the control board determines the voltage or current output. Output voltage range: 0V ~ 10V output current range: 0mA ~ 20mA
Digital output	DO-CME	Digital output 1	Optical coupling isolation, bipolar open collector output voltage range: 0V ~ 24V output current range: 0mA ~ 20mA Note: CME of digital output location is internally isolated from com of digital input location, but at the factory it is shorted to COM via short connector 2CME on the control board (DO1 is driven by + 24v by default at this time). When DO1 is driven by an external power supply, the short connector 2 must be unplugged.
	FM- COM	High speed pulse output	Constrained by function code F4 - 00 " FM terminal output mode selection" as high-speed pulse output, the highest frequency is 100 kHz; When it is exported as open collector, it is the same as DO1 specification.
Communication interface	485+ 485-	Rs485 communication interface terminal	Input and output signal terminals of Modbus - RTU protocol communication
Relay output	T/A-T/B	Normally closed terminal	Contact drive capability: AC250V, 3A, COSφ=0.4. DC 30V, 1A
	T/A-T/C	Normally open terminal	

2.2.4 Standard wiring diagram of frequency inverter

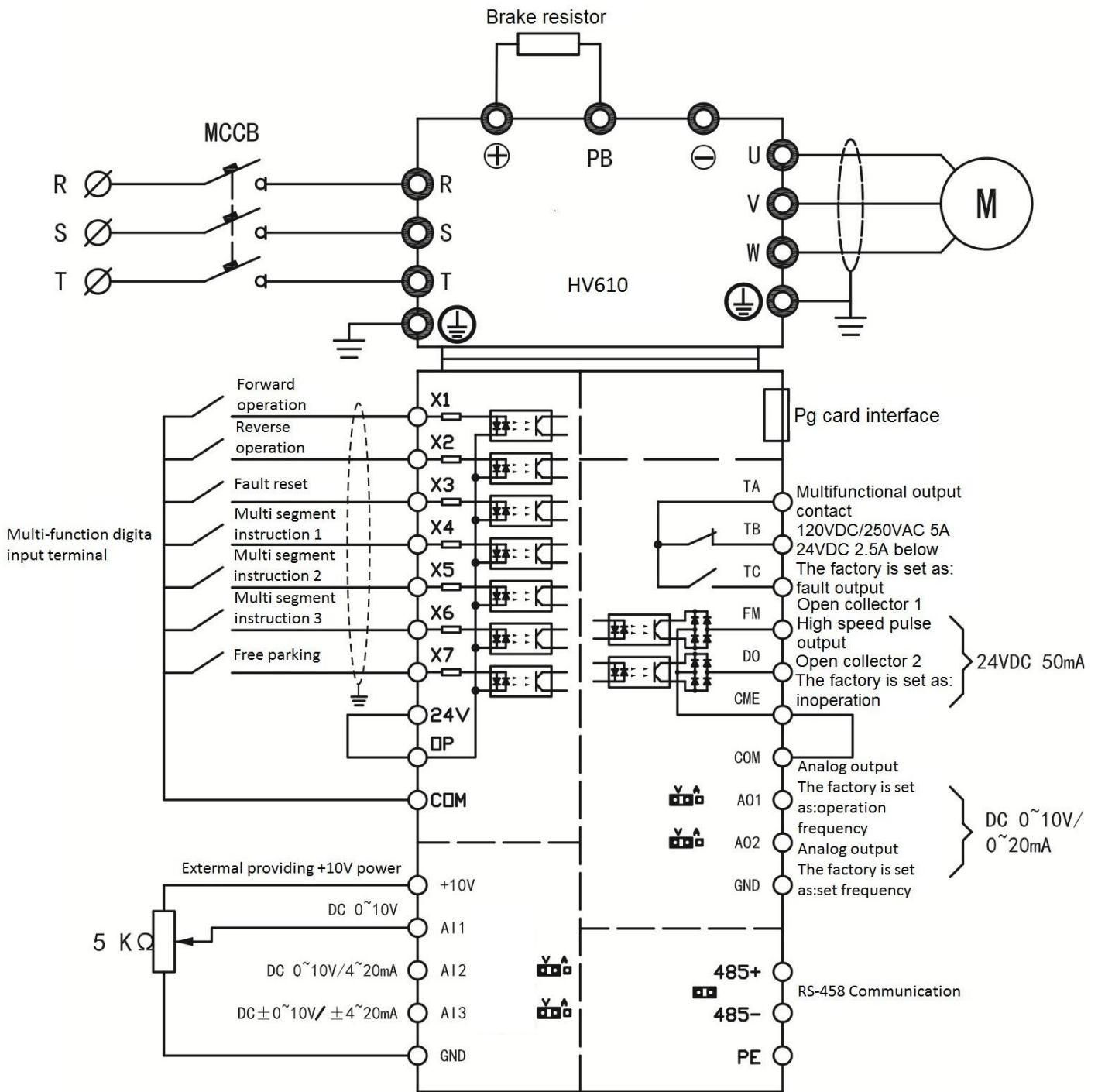

Precautions:

- Terminal  means main circuit terminal and O means control circuit terminal.

2.2.5 Control circuit wiring mode

a) Analog input terminal because weak analog voltage signals are particularly susceptible to external interference, shielded cables are generally required, and the wiring distance should be as short as possible, not exceeding 20m. As shown in the figure, when some analog signals are seriously disturbed, filter capacitors or ferrite cores need to be added to the analog signal source side:

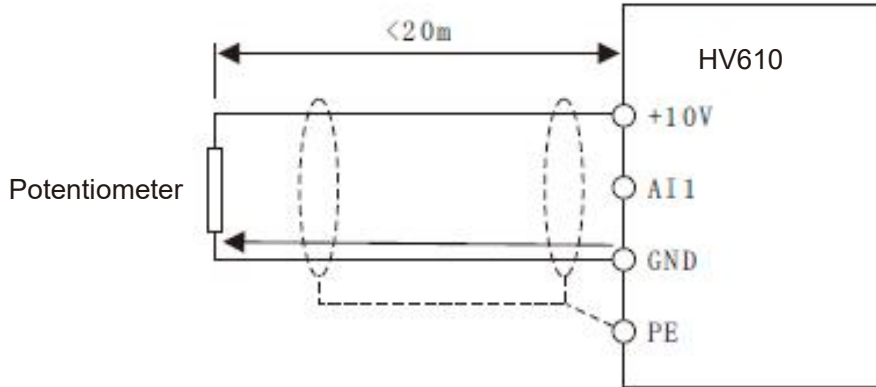

Wiring diagram of analog input terminal

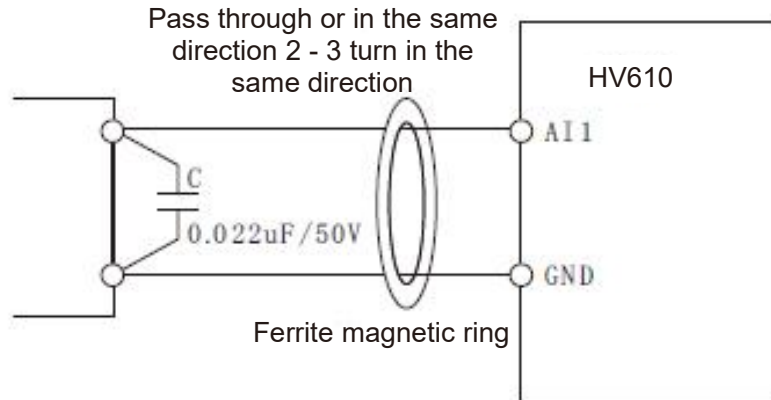

Schematic diagram of processing and wiring for analog input terminals

b) Digital input terminal: Shielded cables are generally required, and the wiring distance should be as short as possible, not exceeding 20m. When active driving mode is selected, necessary filtering measures should be taken for crosstalk of power supply. It is recommended to use contact control square.

- **Leakage wiring**

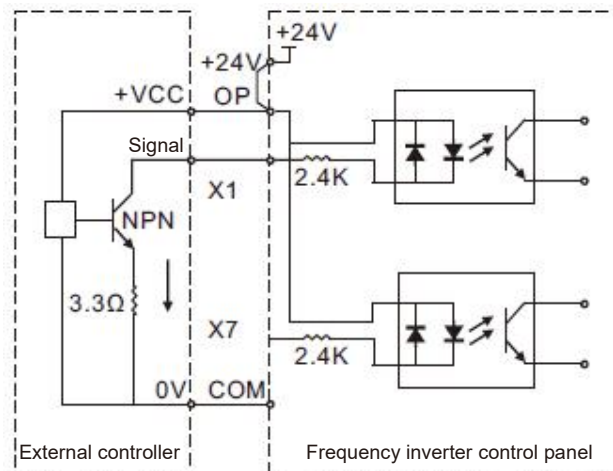

Leakage (NPN) connection mode

This is one of the most common wiring methods. If an external power supply is used, the short connector between +24V and OP and the short connector between COM and CME must be removed. The positive electrode of the external power supply is connected to OP and the negative electrode of the external power supply is connected to CME, and the external trigger signal is connected to the corresponding DI.

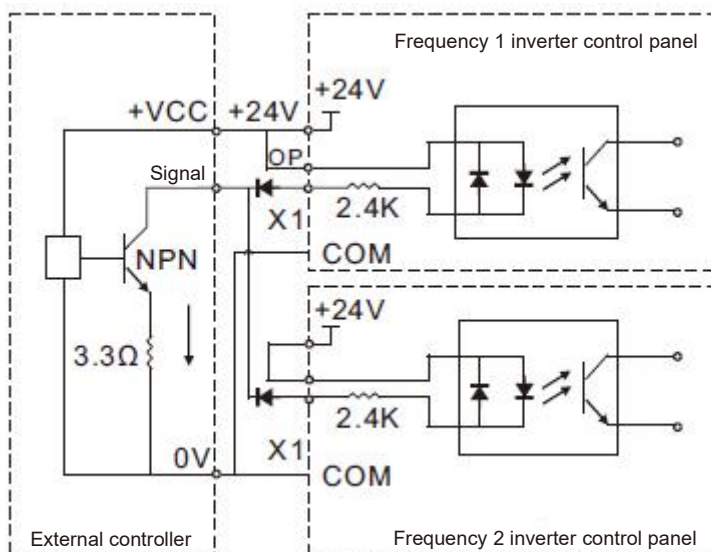

Multiple frequency inverters digital input and connection leakage type connection mode

Multiple frequency inverters digital input terminals cannot be connected and used, otherwise it may cause incorrect operation of the input terminals. If it is needed that the input terminals of different frequency inverters are connected in parallel, the diode is connected in series at the X terminal and the wiring is as shown above and the diode needs to meet $I_F > 10\text{mA}$, $U_F < 1\text{V}$

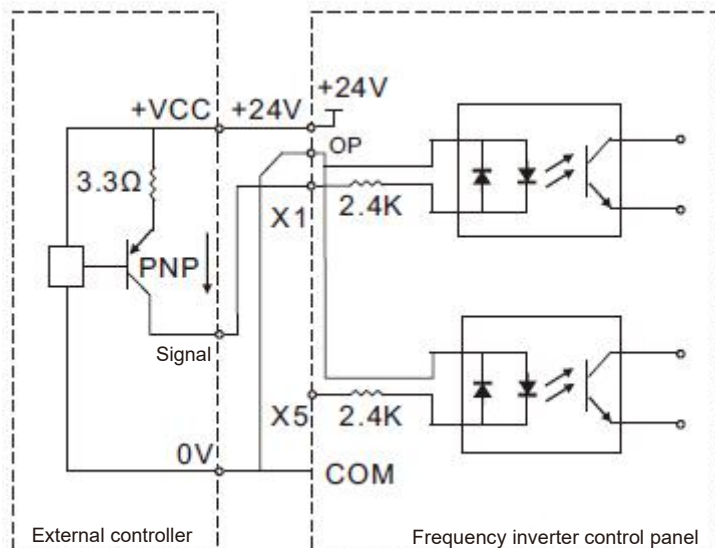

Source type (PNP) wiring mode

This wiring mode must remove the short connectors of +24v and OP, and connect +24v to the common terminal of the external controller together, COM and OP are connected together at the same time. If an external power supply is used, the short connector between COM and CME must also be removed, and the external trigger signal is connected to the corresponding DI.

c) Digital output terminal: When the digital output terminal needs to drive the relay, absorption diodes should be installed on both sides of the relay coil. Otherwise, it is easy to cause damage to the DC 24V power supply and the driving capacity is not more than 50mA.

Note: as shown in the figure, the polarity of the absorption diode must be installed correctly. Otherwise, when the digital output terminal has output, the DC 24V power supply will be burnt out immediately.

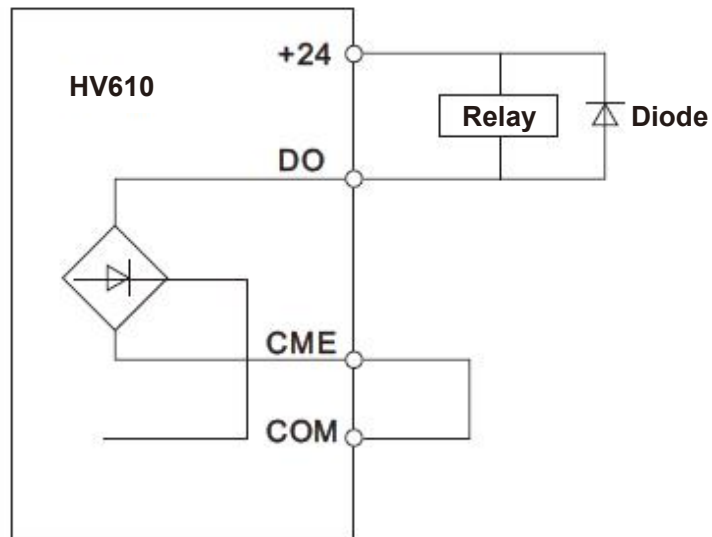

Chapter III Process operation

3.1 Operation keyboard and display interface

The operating keyboard of the series of frequency inverters can modify the functional parameters of the frequency inverter, monitor the working state of the frequency inverter, and control the operation of the frequency inverter (starting and stopping). Its appearance and functional area are shown in the following figure:

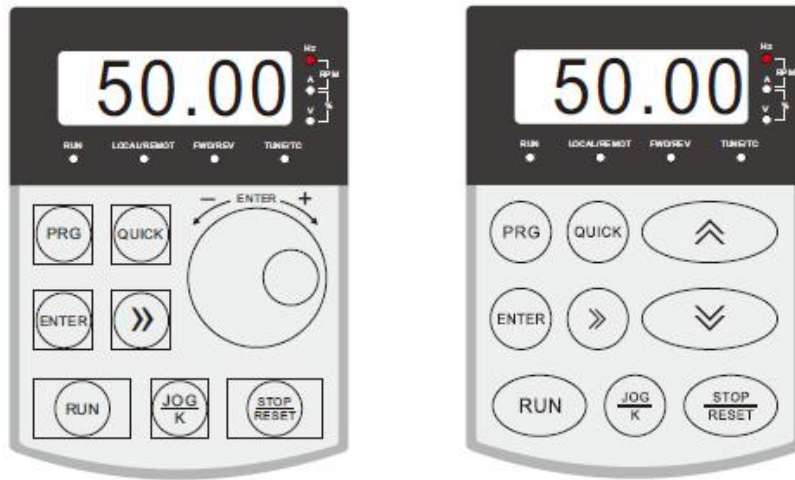









3.2 Indicator light indicates run

- RUN: When the light is on, it indicates that the frequency inverter is in operation, and when the light is off, it indicates that the frequency inverter is in shutdown state
- LOCAL/REMOT: Keyboard operation, terminal operation and remote operation (communication control) indicator light
- FWD/REV: Positive and negative rotation indicator light, which indicates that it is in reverse rotation when the light is on
- TUNE/TC: Tuning / torque control / fault indicator light, light on indicates torque control mode, light slow flashing indicates tuning state, and light flash indicates fault state.

- | | |
|---|--|
| <p>Hz A V
○-RPM-○-%-○</p> | The unit indicator lamp is used to indicate the unit of the current display data (○ marks off, ● marks on). There are the following units: |
| <p>Hz A V
●-RPM-○-%-○</p> | Hz frequency unit |
| <p>Hz A V
○-RPM-●-%-○</p> | A current unit |
| <p>Hz A V
○-RPM-○-%-●</p> | V voltage unit |
| <p>Hz A V
●-RPM-●-%-○</p> | RMP rotational speed unit |
| <p>Hz A V
○-RPM-●-%-●</p> | % percentage |

Total of 5 - bit LED displays can display the set frequency, output frequency, various monitoring data and alarm codes, etc.

3.3 key function description

Key	Key name	Functionalities
	Menu key	Enter or exit the first-level menu and view the function sequence code
	Set key	Enter the menu screen step by step and set parameters for confirmation
	Menu mode select key	Switch different menu modes according to F0 - 43 median value (the default is a menu mode)
	Shift key	Under the shutdown display interface and the operation display interface, the display parameters can be selected according to the loop. When modifying a parameter, you can select the modification bit of the
	Multifunction selection key	According to F0 - 07, function switching can be defined as command source or fast direction switching.
	Run key	When it is set to keyboard control, forward rotation operation instruction will be issued to start the frequency inverter operation.
	Stop / reset key	When running, pressing this key can be used to stop the running operation. When the fault alarm is on, it can be used to reset the operation. And the characteristics of the key are restricted by the function code F0 - 08.
	Increment key	Increment of data or function code
	Descending key	Decrements of data or function code

3.4 Methods of checking and modifying function codes

The operation panel of this series of frequency inverters uses a three-level menu structure to set parameters and other operations.

The three-level menus are: function parameter group (I - level menu) → function code (II - level menu) → function code setting value (level III menu).

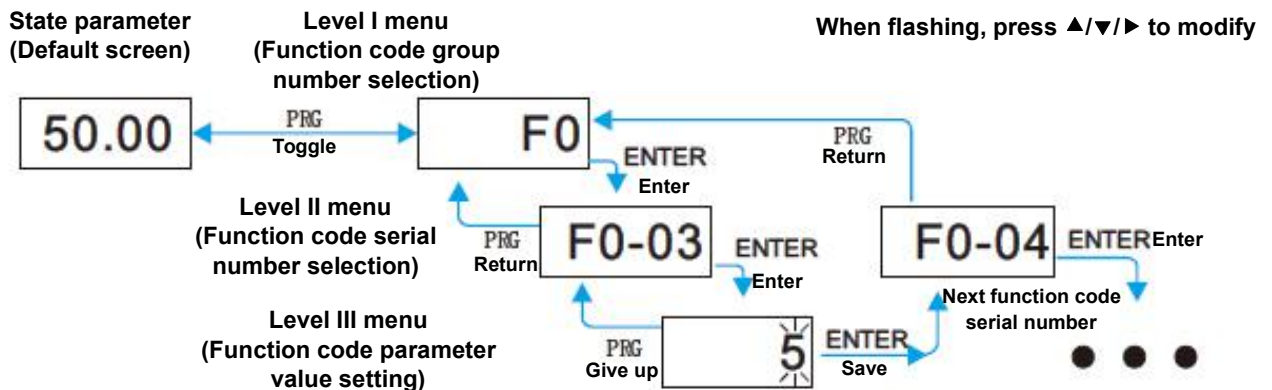

Description: press PRG key or enter key to return to the level II menu when operating the level II menu. The difference between the two is: press enter to save the setting parameters and return to the secondary menu, and

automatically transfer to the next function code; while pressing PRG key is to abandon the current parameter modification and directly return to the secondary menu of the current function code serial number.

Example: example of setting function code F3 - 02 to 15.00 Hz from 10.00 Hz

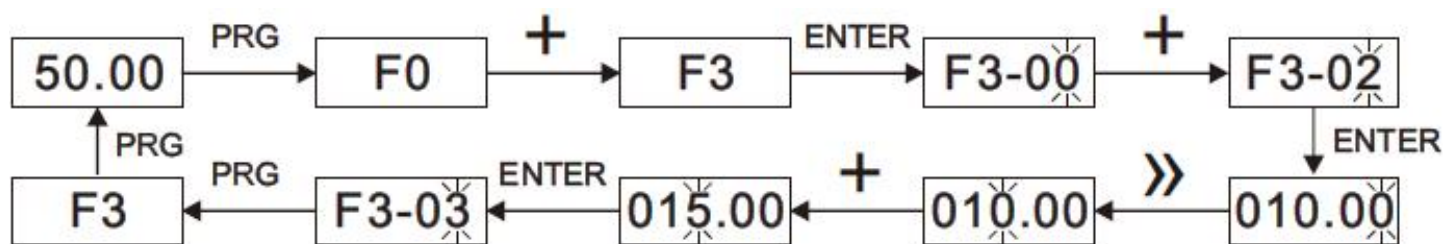

In the level III menu state, if the parameter does not flash, it indicates that the function code cannot be modified. Possible reasons are:

This function code is an unmodified parameter, such as frequency inverter type, actual detection parameter, operation record parameter, etc.

This function code cannot be modified in the running state. It can only be modified after shutdown.

3.5 Two quick search modes for function code parameters there

Are many function codes in this series. In order to facilitate quick search by users, the frequency inverter also provides two quick search methods for function codes:

1) Selecting and customizing common function codes and users, up to 30 of which can be customized, to form a user-defined code function code set; the user determines the function parameters to be displayed through the FE group

2) Automatically arranges the function codes different from the factory values and the frequency inverters for quick selection by the user;

This provides three function code lookup methods, the display code of each parameter display method is:

Parameter display mode	Display
Function parameter mode	--F--
User - customized parameter method	--U--
The method for changing parameters by the users	--C--

The display modes of the three function codes are switched by the quick key on the panel (F0 - 43 is set to 11), and the search or modification method after entering the function codes of each group is the same as that of the previous keyboard operation:

3.6 Commissioning

The series of frequency inverters has three operation control modes, which including keyboard control, terminal control and RS - 485 control. Its control can be selected by setting the function code F0 - 02.

Through keyboard operation, the function code F0 - 02 = 0, i.e. the panel start-stop control mode, presses the run key on the keyboard, and the frequency inverter starts to run (the run indicator lights up); When the frequency inverter is running, press the stop key on the keyboard to stop the frequency inverter (the run indicator goes out)

3.7 Motor characteristic parameter setting and self - learning

When the frequency inverter operates in the "vector control" (F0 - 01 = 0 or 1) mode, it is highly dependent on accurate motor parameters. This is one of the important differences from the "VF control" (F0 - 01 = 2) mode. In order

for the frequency inverter to have good driving performance and operating efficiency, the frequency inverter must obtain the preparation parameters of the controlled motor.

Motor 1 parameter	Parameter description	Description
F1-01 F1-05	Rated power / voltage / current / frequency / speed of motor	Model parameters, manual input
F1-06 F1-20	Equivalent stator resistance, inductance, rotor inductance, etc. inside the motor	Tuning parameter

Methods for obtaining the internal electrical parameters of the controlled motor by the frequency inverter include dynamic identification, static identification, manual input of motor parameters, etc.

Identification method	Application	Identification effect
No - load dynamic identification	Suitable for asynchronous motors. Occasions where the motor and the application system are conveniently separated	Best
On - load dynamic identification	Suitable for asynchronous motors. Where the motor is not easily separated from the application system	May
Static identification	It is only suitable for asynchronous motors, where it is difficult to separate the motor from the load and dynamic identification of operation is not allowed	Poor
Manually enter parameters	It is only suitable for asynchronous motors. When the motor is difficult to separate from the application system, the parameters of the same type of electric machine successfully identified by the frequency inverter are copied and input into the corresponding function codes of F1-00~F1-10	May

Automatic tuning of motor parameters (motor self - learning) steps are as follows:

The following explains the parameter identification method of the default motor 1 as an example. The identification method of the motor 2 is the same as that of the default motor 1, except that the function code number needs to be changed in a targeted way:

- If the motor can be completely disconnected from the load, under the condition of power failure, the motor can be mechanically separated from the load so that the motor can rotate freely without load.
- After power on, first select the frequency inverter command source (F0 - 02) as the operation panel command channel.
- Accurately input the nameplate parameters of the motor (for example, F1-00 ~ F1-05). Please input the parameters of the lower surface according to the actual parameters of the motor (according to the current motor selection)
- If it is an asynchronous motor, then F1 - 29 (tuning selection, for motor 2, it should be FB- 29 function code) please select 2 (asynchronous motor fully tuned), press enter to confirm, at this point, the keyboard shows STUDY, as shown in the following figure:

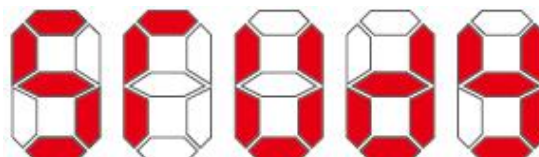

Then press the run key on the panel, the frequency inverter will drive the motor to accelerate and decelerate, rotate forward and backward, the operation indicator light will illuminate, and the operation duration will be recognized for about 2 minutes. When the above display information disappears, the normal parameter display state will be returned, indicating that the tuning is completed. After the complete tuning, the frequency inverter will automatically calculate the following parameters of the motor:

F1 - 06: Asynchronous motor stator resistance

F1 - 07: Asynchronous motor rotor resistance

F1 - 08: Induction motor leakage inductance

F1 - 09: Induction motor mutual inductance resistance

F1 - 10: Asynchronous motor no-load current

If the motor cannot be completely disconnected from the load, F1 - 29 (motor 2 is FB - 29) please select 1 (asynchronous motor is still tuned), and then press the run key on the panel to start the motor parameter identification operation.

Chapter IV Functional parameters

F0 - 46 is set to a value other than 0, i.e. the parameter protection password is set. In the function parameter mode and the user change parameter mode, the parameter menu cannot be entered until the password is correctly entered. To cancel the password, F0 - 46 needs to be set to 0.

Group F and group P are basic functional parameters, and group U is monitoring functional parameters.

4.1 Summary of basic functional parameters

Function code	Name	Setting range	Factory value	Communication address
F0 group basic functions				
F0-00	Menu mode selection	Bits: monitoring group U0 0: Not displayed 1: Display Ten digits: special parameter group P 0: Not displayed 1: Display	11	F000H
F0-01	Control operation mode	0: No PG open loop vector control 1: PG closed loop vector control 2: V/F control	2	F001H
F0-02	Run command channel selection	0: Operation panel 1: Terminals 2: Communication	0	F002H
F0-03	Main frequency source X selection	0: Number setting 1 1: Number setting 2 2: AI1 3: AI2 4: AI3 5: X5 pulse given 6: Multi-segment instruction 7: Simple PLC 8: PID 9: Communication given	1	F003H
F0-04	Anti - reverse selection	0: Allowed 1: Forbidden (0 frequency operation when reverse command is applied)	0	F004H
F0-05	Phase sequence selection	0: Standard 1: Carry out phase sequence exchange. (rotation direction changes)	0	F005H
F0-06	Operation selection when power is on	0: Allowed (when the power supply is turned on and there is an operation command, the operation will start.) 1: Prohibit (even if there is an operation command while the power supply is on, the motor selection is also prohibited.)	0	F006H
F0-07	JOG.K key function selection	0: JOG.K is invalid 1: Operation panel command channel and remote command channel (terminal command channel or communication command channel) switch 2: Forward and reverse switching 3: JOG forward 4: Reverse JOG	0	F007H

Function code	Name	Setting range	Factory value	Communication address
F0-08	STOP/RESET key function	0: STOP / RES key stop function is valid only in keyboard operation mode 1: STOP / RES key stop function is valid in any operation mode	1	F008H
F0-09	Preset frequency	0.00Hz ~ maximum frequency (F0 - 16)	50.00Hz	F009H
F0-10	Acceleration time 1	0.00s~650.00s(F0-12=2) 0.0s~6500.0s(F0-12=1) 0s~65000s(F0-12=0)	Model determination	F00AH
F0-11	Deceleration time 1	0.00s~650.00s(F0-12=2) 0.0s~6500.0s(F0-12=1) 0s~65000s(F0-12=0)	Model determination	F00BH
F0-12	Acceleration / deceleration time unit	0: 1 second 1: 0.1 second 2: 0.01 second	1	F00CH
F0-13	Acceleration and deceleration time reference frequency	0: maximum frequency (F0 - 12) 1: set frequency 2: 100Hz	0	F00DH
F0-14	Shutdown mode	0: slow down and stop 1: free parking	0	F00EH
F0-15	Droop control	0.00Hz~10.00Hz	0.00Hz	F00FH
F0-16	Maximum frequency	50.00Hz~500.00Hz(F0-25=2) 50.0Hz~3200.0Hz(F0-25=1)	50.00Hz	F010H
F0-17	Upper frequency source	0: F0 - 18 settings 1: AI1 2: AI2 3: AI3 4: X5 pulse setting 5: Communication given	0	F011H
F0-18	Upper limiting frequency	Lower frequency F0 - 20 ~ maximum frequency F0 - 16	50.00Hz	F012H
F0-19	Upper frequency offset	0.00Hz ~ maximum frequency F0 - 16	0.00Hz	F013H
F0-20	Lower limit frequency	0.00Hz ~ upper frequency F0 - 18	0.00Hz	F014H
F0-21	Operating mode with set frequency lower than lower limit frequency	0: The following limited frequency operation 1: Shutdown 2: Zero speed operation	0	F015H
F0-22	Carrier frequency	0.5kHz~16.0kHz	Model determination	F016H
F0-23	Carrier frequency adjusts with load	0: No 1: Yes	1	F017H
F0-24	LED shutdown operation display selection	0: Shutdown operation display separated 1: Stop operation display does not separate	0	F018H
F0-25	Frequency decimal point	1: One decimal point 2: Two decimal points	2	F019H
F0-26	Digital setting frequency shutdown memory selection	0: No memory 1: Memory	1	F01AH

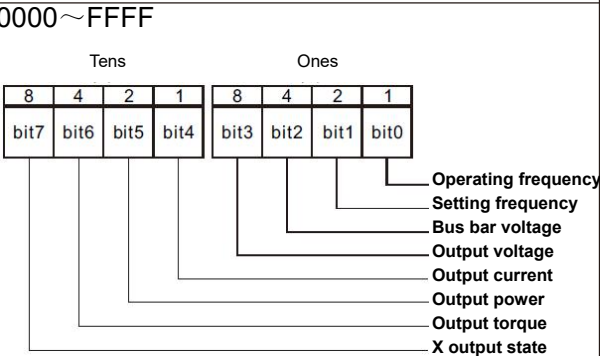
Function code	Name	Setting range	Factory value	Communication address
F0-27	Runtime frequency command UP / DOWN reference	0: Operating frequency 1: Set frequency	1	F01BH
F0-28	Motor selection	0: Motor 1 1: Motor 2	0	F01CH
F0-29	Auxiliary frequency source Y	Same as F0 - 03 (main frequency source X)	0	F01DH
F0-30	Base value of auxiliary frequency Y range during superposition	0: Relative to maximum frequency 1: Relative to frequency source x	0	F01EH
F0-31	Auxiliary frequency Y range during superposition	0% - 150%	100%	F01FH
F0-32	Frequency superposition	Bits: frequency selection 0: Main frequency x 1: Main and auxiliary operation results (the operation relationship is defined by ten - digit confirmation) 2: Switch between main frequency X and auxiliary frequency Y. 3: Switching between main frequency X and main and auxiliary operation results 4. The auxiliary frequency Y is cut OFF from the result of the main and auxiliary operations change 10 Bits: frequency primary and secondary operation relation 0: Primary + secondary 1: Primary and secondary 2: Maximum value of both 3: Minimum of both	00	F020H
F0-33	Auxiliary frequency source offset frequency during superposition	0.00Hz ~ maximum frequency F0 - 16	0.00Hz	F021H
F0-34	Command source bundling frequency source	Bits: operation panel command binding frequency source selection 0: Unbound 1: Number setting 2: AI1 3: AI2 4: AI3 5: X5 pulse quantity setting 6: Multi-segment instruction 7: Simple PLC 8: PID 9: Communication given Ten bits: terminal command binding frequency source selection Hundred bits: communication command binding frequency source selection	0000	F022H
F0-35	Cooling fan control	0: Fan running when running 1: The fan is running all the time	0	F023H
F0-36	Forward and reverse dead time	0.0s ~ 3000.0s	0.0s	F024H
F0-37	Parameter 1 displayed at run time	0000 ~ FFFF 	H401F	F025H

Function code	Name	Setting range	Factory value	Communication address																																
		<p>Kilobit Hundreds</p> <table border="1"> <tr> <td>8</td><td>4</td><td>2</td><td>1</td> <td>8</td><td>4</td><td>2</td><td>1</td> </tr> <tr> <td>bit15</td><td>bit14</td><td>bit13</td><td>bit12</td> <td>bit11</td><td>bit10</td><td>bit9</td><td>bit8</td> </tr> </table> <p>DO output state A1 voltage A12 voltage A13 voltage Count value Length value Load speed PID setting</p>	8	4	2	1	8	4	2	1	bit15	bit14	bit13	bit12	bit11	bit10	bit9	bit8																		
8	4	2	1	8	4	2	1																													
bit15	bit14	bit13	bit12	bit11	bit10	bit9	bit8																													
F0-38	Parameter 2 displayed at run time	<p>0000~FFFF</p> <p>Tens Ones</p> <table border="1"> <tr> <td>8</td><td>4</td><td>2</td><td>1</td> <td>8</td><td>4</td><td>2</td><td>1</td> </tr> <tr> <td>bit7</td><td>bit6</td><td>bit5</td><td>bit4</td> <td>bit3</td><td>bit2</td><td>bit1</td><td>bit0</td> </tr> </table> <p>PID feedback PLC stage PLUSE input pulse frequency Sync frequency Remaining run time A1 pre-calibration voltage A2 pre-calibration voltage A3 pre-calibration voltage</p> <p>Kilobit Hundreds</p> <table border="1"> <tr> <td>8</td><td>4</td><td>2</td><td>1</td> <td>8</td><td>4</td><td>2</td><td>1</td> </tr> <tr> <td>bit15</td><td>bit14</td><td>bit13</td><td>bit12</td> <td>bit11</td><td>bit10</td><td>bit9</td><td>bit8</td> </tr> </table> <p>Linear speed Current power-on time Current operating time Input pulse frequency Hz Communication set point Encoder feedback speed Main frequency X Secondary frequency Y</p>	8	4	2	1	8	4	2	1	bit7	bit6	bit5	bit4	bit3	bit2	bit1	bit0	8	4	2	1	8	4	2	1	bit15	bit14	bit13	bit12	bit11	bit10	bit9	bit8	0	F026H
8	4	2	1	8	4	2	1																													
bit7	bit6	bit5	bit4	bit3	bit2	bit1	bit0																													
8	4	2	1	8	4	2	1																													
bit15	bit14	bit13	bit12	bit11	bit10	bit9	bit8																													
F0-39	Parameter displayed at stop	<p>0000~FFFF</p> <p>Tens Ones</p> <table border="1"> <tr> <td>8</td><td>4</td><td>2</td><td>1</td> <td>8</td><td>4</td><td>2</td><td>1</td> </tr> <tr> <td>bit7</td><td>bit6</td><td>bit5</td><td>bit4</td> <td>bit3</td><td>bit2</td><td>bit1</td><td>bit0</td> </tr> </table> <p>Set frequency Bus voltage X terminal input state DO output state A1 voltage A12 voltage A13 voltage Count value</p> <p>Kilobit Hundreds</p> <table border="1"> <tr> <td>8</td><td>4</td><td>2</td><td>1</td> <td>8</td><td>4</td><td>2</td><td>1</td> </tr> <tr> <td>bit15</td><td>bit14</td><td>bit13</td><td>bit12</td> <td>bit11</td><td>bit10</td><td>bit9</td><td>bit8</td> </tr> </table> <p>Length value PLC stage Load speed PID sets X5 input frequency</p>	8	4	2	1	8	4	2	1	bit7	bit6	bit5	bit4	bit3	bit2	bit1	bit0	8	4	2	1	8	4	2	1	bit15	bit14	bit13	bit12	bit11	bit10	bit9	bit8	33	F027H
8	4	2	1	8	4	2	1																													
bit7	bit6	bit5	bit4	bit3	bit2	bit1	bit0																													
8	4	2	1	8	4	2	1																													
bit15	bit14	bit13	bit12	bit11	bit10	bit9	bit8																													
F0-40	Speed display coefficient	0.0001 ~ 6.5000	3.0000	F028H																																
F0-41	speed display decimal point setting	<p>Bits: U0 - 14 decimal places 0: 0 decimal places 1: 1 decimal place 2: 2 decimal places 3: 3 decimal places 10 bits: U0 - 19 / U0 - 29 decimal places 1: 1 decimal places 2: 2 decimal places</p>	21	F029H																																

Function code	Name	Setting range	Factory value	Communication address
F0-43	Special menu selection	Bits: user customized parameter group display selection 0: not displayed 1: display 10 bits: user changes parameter group display selection 0: not displayed 1:Display	00	F02BH
F0-44	Parameter access level	0: modifiable, monitor able 1: all cannot be modified and only monitored	0	F02CH
F0-45	Keyboard knob sensitivity	0~3	2	F02DH
F0-46	User password	0~65535	0	F02EH
F0-47	Parameter initialization	0: no operation 1001: restore factory parameters, excluding electrical machine parameters 1002: resetting recording information	0	F02FH
F1 first motor parameter				
F1-01	Rated power of asynchronous motor	0.1kW~1000.0kW	Model determination	F101H
F1-02	Rated voltage of asynchronous motor	1V~2000V	Model determination	F102H
F1-03	Rated current of asynchronous motor	0.01A~655.35A (inverter power <=55kW) 0.1A ~ 6553.5A (frequency inverter power >55kW)	Model determination	F103H
F1-04	Rated frequency of asynchronous motor	0.01 Hz ~ maximum frequency	Model determination	F104H
F1-05	Rated speed of asynchronous motor	1rpm~65535rpm	Model determination	F105H
F1-06	Stator resistance R1	0.001Ω~ 65.535Ω (frequency inverter power <=55kW) 0.0001 ~ 6.5535 (frequency inverter power >55kW)	Tuning parameter	F106H
F1-07	Rotor resistance R2	0.001Ω~ 65.535Ω (frequency inverter power <=55kW) 0.0001 ~ 6.5535 (frequency inverter power >55kW)	Tuning parameter	F107H
F1-08	Leakage reactance L1	0.01 mH ~ 655.35 mH (frequency inverter power <=55kW) 0.001 ~ 65.535 mH (frequency inverter work rate > 55 kW)	Tuning parameter	F108H
F1-09	Mutual inductance resistance L2	0.1 mH ~ 6553.5 mH (frequency inverter power <=55kW) 0.01 mH ~ 655.35 mH (frequency inverter power >55kW)	Tuning parameter	F109H
F1-10	No-load current I0	0.01A ~ F1 - 03 (frequency inverter power <=55kW) 0.1A ~ F1 - 03 (frequency inverter power >55kW)	Tuning parameter	F10AH

Function code	Name	Setting range	Factory value	Communication address
F1-27	Encoder line number	1~65535	1024	F11BH
F1-28	Encoder type	0: ABZ incremental encoder 1: UVW incremental encoder 2: resolver 3: sine and cosine encoder 4: provincial UVW encoder	0	F11CH
F1-29	Parameter self - tuning	0: no operation 1: simple static self - tuning 2: rotational self - tuning 3. advanced static self - tuning	0	F11DH
F1-30	AB phase sequence of ABZ incremental encoder	0: forward 1: reverse	0	F11EH
F1-31	Encoder mounting angle	0.0~359.9°	0.0°	F11FH
F1-32	UVW phase sequence of UVW encoder	0: forward 1: reverse	0	F120H
F1-33	UVW encoder offset angle	0.0~359.9°	0.0°	F121H
F1-34	Polar logarithm of resolver	1~65535	1	F122H
F1-36	Speed feedback PG disconnection detection time	0.0s~10.0s	0.0s	F123H
F2 group of first motor vector control parameters				
F2-00	ASR_P1	1~100	30	F200H
F2-01	ASR_I1	0.01s~10.00s	0.50s	F201H
F2-02	Gain switching frequency of ASR 1	0.00~F2-05	5.00Hz	F202H
F2-03	ASR_P2	1~100	20	F203H
F2-04	ASR_I2	0.01s~10.00s	1.00s	F204H
F2-05	Gain switching frequency of ASR 2	F2 - 02 ~ maximum frequency	10.00Hz	F205H
F2-06	Vector controlled slip gain	50% - 200%	100%	F206H
F2-07	Velocity loop filtering time	0.000~1.000s	0.050s	F207H
F2-09	Torque upper limit source under speed control mode	0: function code F2 - 10 setting 1: AI1 2: AI2 3: AI3 4: X5 pulse 5: communication given 6: MIN(AI1,AI2) 7: MAX(AI1,AI2) The full scale of the 1 - 7 option corresponds to F2 - 10	0	F209H
F2-10	Numerical setting of upper limit of torque under speed control mode	0.0% - 200.0%	150.0%	F20AH
F2-18	Selection of weak magnetic mode in vector mode	0: not enabled 1: deceleration only enabled 2. constant speed and deceleration enable	0	F212H
F2-19	Over modulation enable selection	0: not enabled 1: enable	0	F213H
F2-20	Over modulation coefficient	100: 110%	100	F214H
F2-21	Weak magnetic moment coefficient	50: 200%	100	F215H

Function code	Name	Setting range	Factory value	Communication address
F3 group V/F control parameters				
F3-00	V/F curve setting	0: straight line V/F 1: multi-segment V/F(F3 - 03 ~ F3 - 08) 2: square V/F 3: 1.2 Exponentiation V/F 4: 1.4 Exponentiation V/F 6: 1.6 Exponentiation V/F 8: 1.8 Exponentiation V/F 9: reservations 10: VF complete separation mode 11: VF semi-separation mode	0	F300H
F3-01	Torque increase	0.0 %: (automatic torque boost) 0.1%~30.0%	Model determination	F301H
F3-02	Torque boost cutoff frequency	0.00Hz ~ maximum frequency	50.00Hz	F302H
F3-03	V/F frequency point F0	0.00Hz~F3-05	0.00Hz	F303H
F3-04	V/F voltage point V0	0.0%~100.0%	0.0%	F304H
F3-05	V/F frequency point F1	F3-03~F3-07	0.00Hz	F305H
F3-06	V/F voltage point V1	0.0%~100.0%	0.0%	F306H
F3-07	V/F frequency point F2	F3 - 05 ~ rated frequency of motor (F1 - 04)	0.00Hz	F307H
F3-08	V/F voltage point V2	0.0%~100.0%	0.0%	F308H
F3-09	V/F slip compensation gain	0.0%~200.0%	0.0%	F309H
F3-10	V/F over-excitation gain	0~200	64	F30AH
F3-11	V/F oscillation suppression gain	0~100	Model determination	F30BH
F3-12	Oscillation suppression gain mode	0~4	3	F30CH
F3-13	Voltage selection for V/F separation	0: numerical setting (F3 - 14) 1: AI1 2: AI2 3: AI3 4: PULSE pulse setting (X5) 5: multi-segment instruction 6: simple PLC 7: PID 8: communication given note: 100.0 % corresponding motor rated voltage	0	F30DH
F3-14	V/F separated voltage number word setting	0V ~ rated voltage of motor	0V	F30EH
F3-15	V/F separation voltage acceleration time	0.0s~1000.0s Note: indicates the time when 0v changes to the rated voltage of the motor	0.0s	F30FH

Function code	Name	Setting range	Factory value	Communication address
F3-16	V/F separation voltage deceleration time	0.0s~1000.0s Note: indicates the time when 0v changes to the rated voltage of the motor	0.0s	F310H
F3-17	V/F separation shutdown option	0: frequency / voltage independently reduced to 0 1: the frequency decreases again after the voltage decreases to 0	0	F311H

Function code	Name	Setting range	Factory value	Communication address
F4 group output terminals				
F4-00	FM terminal output mode selection	0: pulse output 1: switch output	0	F400H
F4-01	FM switch output power selection	0: no output 1: the frequency inverter is running 2: fault output (fault for free shutdown) 3: frequency level detection FD t1 output 4: frequency arrival 5: zero speed operation (no output during shutdown) 6: motor overload pre - alarm 7: frequency inverter overload pre - alarm 8: set the count value to reach 9: specified count value arrives 10: length arrives	0	F401H
F4-02	Function selection of control panel relay 1 (T/A-T/B-T/C)	11: PLC cycle completed 12: accumulated operating time arrives 13: frequency limit 14: torque limit 15: operational readiness 16: AI1>AI2 17: upper limit frequency reached 18: lower limit frequency reached (operation related) 19: under voltage state output 20: communication settings 21: positioning completed (reserved) 22: positioning approach (reserved) 23: zero speed operation in 2 (output when shutdown)	2	F402H
F4-03	Function selection of control panel relay 2 (T/A-T/B-T/C)	24: cumulative power-on time arrives 25: frequency level detection FD T2 output 26: frequency 1 reaches output 27: frequency 2 reaches output 28: current 1 reaches output 29: current 2 reaches output 30: arrive at output regularly		
F4-04	DO1 output function selection	31: AI1 input overrun 32: falling load 33: reverse operation 34: zero current state 35: module temperature reached 36: output current exceeds limit 37: lower limit frequency reached (shutdown also output) 38: alarm output (all faults) 39: motor over temperature pre - alarm 40: the running time has arrived 41: fault output (fault for free shutdown And under-voltage does not output) 42: AI1 is lower than lower limit output, lower limit F4 - 37 43: AI1 above upper limit output, upper limit F4 - 38 44: AI2 is lower than lower limit output, lower limit F4 - 37 45: AI2 above upper limit output, upper limit F4 - 38	1	F404H

Function code	Name	Setting range	Factory value	Communication address
F4-06	FM pulse output function selection	0: operating frequency 1: set frequency 2: Output current 3: output torque (absolute value of torque)	0	F406H
F4-07	AO1 output function selection	4: output power 5: Output voltage 6: PULSE input (100.0 % corresponding 100.0kHz) 7: AI1 8: AI2 9: AI3	0	F407H
F4-08	AO2 output function selection	10: length 11: remember values 12: communication settings 13: motor speed 14: output current (100.0 % corresponding 1000.0A) 15: output voltage (100.0 % corresponding 1000.0V) 16: output torque (actual torque value)	1	F408H
F4-09	FM pulse output maximum frequency	0.01kHz~100.00kHz	50.00kHz	F409H
F4-10	AO1 zero offset coefficient	-100.0%~+100.0%	0.0%	F40AH
F4-11	AO1 gain	-10.00~+10.00	1.00	F40BH
F4-12	AO2 zero offset coefficient	-100.0%~+100.0%	0.0%	F40CH
F4-13	AO2 gain	-10.00~+10.00	1.00	F40DH
F4-17	Delay time of FM switch output	0.0s~3600.0s	0.0s	F411H
F4-18	Relay 1 output delay time	0.0s~3600.0s	0.0s	F412H
F4-19	Relay 2 output delay time	0.0s~3600.0s	0.0s	F413H
F4-20	DO1 output delay time	0.0s~3600.0s	0.0s	F014H
F4-21	DO2 output delay time	0.0s~3600.0s	0.0s	F015H
F4-22	DO output terminal active state selection	0: positive logic 1: reverse logic bits: FM 10 bits: relay 1 100 bits: relay 2 1000 bits: DO1 10,000 bits: DO2	00000	F416H
F4-24	Frequency detection value (FDT1)	0.00Hz ~ maximum frequency	50.00Hz	F418H
F4-25	Frequency detection lag value (FDT1)	0.0 % ~ 100.0 % (FDT1 level)	5.0%	F419H

Function code	Name	Setting range	Factory value	Communication address
F4-26	Frequency detection value (FDT2)	0.00Hz ~ maximum frequency	50.00Hz	F41AH
F4-27	Frequency detection lag value (FDT2)	0.0 % ~ 100.0 % (FDT2 level)	5.0%	F41BH
F4-28	Frequency reaches detection width	0.0 % ~ 100.0 % (maximum frequency)	0.0%	F41CH
F4-29	Random arrival frequency check value 1	0.00Hz ~ maximum frequency	50.00Hz	F41DH
F4-30	Random arrival frequency detects width 1	0.0 % ~ 100.0 % (maximum frequency)	0.0%	F41EH
F4-31	Random arrival frequency check value 2	0.00Hz ~ maximum frequency	50.00Hz	F41FH
F4-32	Random arrival frequency detects width 2	0.0 % ~ 100.0 % (maximum frequency)	0.0%	F420H
F4-33	Arbitrarily reaching current 1	0.0 % ~ 300.0 % (rated current of motor)	100.0%	F421H
F4-34	The width of current 1 is arbitrarily reach	0.0 % ~ 300.0 % (rated current of motor)	0.0%	F422H
F4-35	Arbitrarily reaching current 2	0.0 % ~ 300.0 % (rated current of motor)	100.0%	F423H
F4-36	The width of current 2 is arbitrarily reach	0.0 % ~ 300.0 % (rated current of motor)	0.0%	F424H
F4-37	A11 input voltage protection value lower limit	0.00V~F4-38	3.10V	F425H
F4-38	A11 upper limit of input voltage protection value	F4-37~10.00V °C	6.80V	F426H
F4-39	Module temperature reached	0°C~100°C	75°C	F427H
F4-40	Zero current detection level	0.0% ~ 300.0% 100.0 % corresponding motor rated current	5.0%	F428H
F4-41	Zero current detection delay time	0.01s~600.00s	0.10s	F429H
F4-42	Output current overrun value	0.0 % (no detection) 0.1 % ~ 300.0 % (rated current of motor)	200.0%	F42AH
F4-43	Output current overrun detection delay time	0.00s~600.00s	0.00s	F42BH
F5 group input terminals				
F5-00	X1 input terminal function selection	0: no function 1: forward run FWD or run command 2: reverse operation REV or reverse operation direction (note: when set to 1 and 2, it should be used in conjunction with F5 - 11. for details, please refer to the description of function code parameters) 3: three-wire operation control 4: Forward JOG (FJOG 5: reverse JOG (RJOG) 6: terminal UP	1	F500H
F5-01	X2 input terminal function selection		2	F501H

Function code	Name	Setting range	Factory value	Communication address
F5-02	X3 input terminal function selection	7: terminal DOWN 8: free parking 9: fault reset (RESET) 10: suspension of operation 11: external fault normally open input 12: multi-segment command terminal 1 13: multi-segment command terminal 2 14: multi-segment command terminal 3 15: multi-segment command terminal 4	9	F502H
F5-03	X4 input terminal function selection	16: acceleration and deceleration time selection terminal 1 17: acceleration and deceleration time selection terminal 2 18: frequency source switching 19: UP / DOWN setting cleared (terminal keyboard) 20: control command switching terminal 1	12	F503H
F5-04	X5 input terminal function selection	21: prohibition of acceleration and deceleration 22: PID pause 23: PLC status reset 24: frequency swing suspended 25: counter input 26: counter reset 27: length count input 28: length reset	13	F504H
F5-05	X6 input terminal function selection	29: torque control prohibited 30: PULSE frequency input (valid only for X5) 31: reservations 32: direct current brake immediately 33: external fault normally closed input 34: frequency modification enabled 35: the direction of PID action is reversed	14	F505H
F5-06	X7 input terminal function selection	36: external parking terminal 1 37: control command switching terminal 2 38: PID integral suspended 39: frequency source X switches to preset frequency 40: frequency source Y and preset frequency switch 41: motor selection terminal 1 42: reservations 43: PID parameter switching 44: user-defined failure 1 45: user-defined failure 2 46: speed control / torque control switching 47: Emergency stop button 48: External parking terminal 2 49: deceleration DC brake 50: this run time is cleared 51: 2 - wire / 3 - wire switch 52: Prohibition of reversal 53: zero speed function 54: Frequency source switching 2 55: frequency source switch to multi-segment speed	8	F506H
F5-10	X terminal filtering time	0.000s~1.000s	0.010s	F50AH
F5-11	Terminal command mode	0: 2 - wire type 1 1: 2 - wire type 2 2: 3 - wire type 1 3: 3 - wire type 2	0	F50BH
F5-12	Terminal UP / DOWN change rate	0.001Hz/s~65.535Hz/s	1.00Hz/s	F50CH

Function code	Name	Setting range	Factory value	Communication address
F5-13	PULSE minimum input	0.00kHz~F5-15	0.00kHz	F50DH
F5-14	PULSE minimum input correspondence setting	-100.0%~100.0%	0.0%	F50EH
F5-15	PULSE maximum input	F5-13~100.00kHz	50.00kHz	F50FH
F5-16	PULSE maximum input setting	-100.0%~100.0%	100.0%	F510H
F5-17	PULSE filtering time	0.00s~10.00s	0.10s	F511H
F5-18	X1 delay time	0.0s~3600.0s	0.0s	F512H
F5-19	X2 delay time	0.0s~3600.0s	0.0s	F513H
F5-20	X3 delay time	0.0s~3600.0s	0.0s	F514H
F5-21	X terminal valid logic 1	0: active high 1: low level valid bits: X1 10 bits: X2 10 bits: X3 1000 bits: X4 10,000 bits: X5	00000	F515H
F5-22	X terminal valid logic2	0: active high 1: low level valid bits: X6 10 bits: X7	00000	F516H
F5-24	AI curve 1 minimum input	0.00V~F5-26	0.00V	F518H
F5-25	AI curve 1 minimum input corresponding settings	-100.0%~+100.0%	0.0%	F519H
F5-26	AI curve 1 maximum input	F5-24~+10.00V	10.00V	F51AH
F5-27	AI curve 1 maximum input corresponding setting	-100.0%~+100.0%	100.0%	F51BH
F5-28	AI1 filtering time	0.00s~10.00s	0.10s	F51CH
F5-29	AI curve 2 minimum input	0.00V~F5-31	0.00V	F51DH
F5-30	AI curve 2 minimum input corresponding settings	-100.0%~+100.0%	0.0%	F51EH
F5-31	AI curve 2 maximum input	F5-29~+10.00V	10.00V	F51FH
F5-32	AI curve 2 maximum input corresponding setting	-100.0%~+100.0%	100.0%	F520H
F5-33	AI2 filtering time	0.00s~10.00s	0.10s	F521H
F5-34	AI curve 3 minimum input	-10.00V~F5-36	-10.00V	F522H

Function code	Name	Setting range	Factory value	Communication address
F5-35	AI curve 3 minimum input corresponding settings	-100.0%~+100.0%	-100.0%	F523H
F5-36	AI curve 3 maximum input	F5-34~+10.00V	10.00V	F524H
F5-37	AI curve 3 maximum input corresponding setting	-100.0%~+100.0%	100.0%	F525H
F5-38	AI3 filtering time	0.00s~10.00s	0.10s	F526H
F5-39	AI curve selection	Bits: AI1 curve selection 1: curve 1 (2 points, see F5 - 24 ~ F5 - 28) 2: curve 2 (2 points, see F5 - 29 ~ F5 - 33) 3: curve 3 (2 points, see F5 - 34 ~ F5 - 38) 4: curve 4 (4 points, see F5 - 41 ~ F5 - 48) 5: curve 5 (4 points, see F5 - 49 ~ F5 - 56) 10 bits: AI2 curve selection, same as above 100 bits: AI3 curve selection, same as above	321	F527H
F5-40	AI is lower than the minimum input setting selection	Bits: AI1 lower than minimum input setting selection 0: corresponding minimum input setting 1:0.0% 10 bits: AI2 is lower than the minimum input setting selection, same as above 100 bits: AI3 is lower than the minimum input setting selection, same as above	0	F528H
F5-41	AI curve 4 minimum input	-10.00V~F5-43	0.00V	F529H
F5-42	AI curve 4 minimum input corresponding settings	-100.0%~+100.0%	0.0%	F52AH
F5-43	AI curve 4 inflection point 1 input	F5-41~F5-45	3.00V	F52BH
F5-44	AI curve 4 inflection point 1 input corresponding settings	-100.0%~+100.0%	30.0%	F52CH
F5-45	AI curve 4 inflection point 2 input	F5-43~F5-47	6.00V	F52DH
F5-46	AI curve 4 inflection point 2 input corresponding settings	-100.0%~+100.0%	60.0%	F52EH
F5-47	AI curve 4 maximum input	F5-45~+10.00V	10.00V	F52FH
F5-48	AI curve 4 maximum input corresponding setting	-100.0%~+100.0%	100.0%	F530H
F5-49	AI curve 5 minimum input	-10.00V~F5-51	-10.00V	F531H
F5-50	AI curve 5 minimum input corresponding settings	-100.0%~+100.0%	-100.0%	F532H
F5-51	AI curve 5 inflection point 1 input	F5-49~F5-53	-3.00V	F533H
F5-52	AI curve 5 inflection point 1 input corresponding settings	-100.0%~+100.0%	-30.0%	F534H
F5-53	AI curve 5 inflection point 2 input	F5-51~F5-55	3.00V	F535H
F5-54	AI curve 5 inflection point 2 input corresponding settings	-100.0%~+100.0%	30.0%	F536H

Function code	Name	Setting range	Factory value	Communication address
F5-55	AI curve 5 maximum input	F5-53 ~ +10.00V	10.00V	F537H
F5-56	AI curve 5 maximum input corresponding setting	-100.0% ~ +100.0%	100.0%	F538H
F5-65	AI1 sets jumping point	-100.0% ~ 100.0%	0.0%	F541H
F5-66	AI1 sets jump amplitude	0.0% ~ 100.0%	0.5%	F542H
F5-67	AI2 sets jumping point	-100.0% ~ 100.0%	0.0%	F543H
F5-68	AI2 sets jump amplitude	0.0% ~ 100.0%	0.5%	F544H
F5-69	AI3 sets jumping point	-100.0% ~ 100.0%	0.0%	F545H
F5-70	AI3 sets jump amplitude	0.0% ~ 100.0%	0.5%	F546H
F5-71	Reserved	Reserved	--	--
F5-72	Reserved	Reserved	--	--
F6 group start-stop control				
F6-00	Starting mode	0: direct startup 1: speed tracking restart 2: pre-excitation start - up	0	F600H
F6-01	Speed tracking mode	0: starting from shutdown frequency 1: starting from zero speed 2: starting from the maximum frequency	0	F601H
F6-02	Speed tracking speed	1 ~ 100	20	F602H
F6-03	Starting frequency	0.00Hz ~ 10.00Hz	0.00Hz	F603H
F6-04	Start frequency hold time	0.0s ~ 100.0s	0.0s	F604H
F6-05	Start DC brake current / pre-excitation current	0% ~ 100%	0%	F605H
F6-06	Dc brake start time / pre-excitation time	0.0s ~ 100.0s0.	0s	F606H
F6-07	Stop DC brake starting frequency	0.00Hz ~ maximum frequency	0.00Hz	F607H
F6-08	Waiting time for shutdown, DC braking, etc	0.0s ~ 100.0s	0.0s	F608H
F6-09	Stop DC brake current	0% - 100%	0%	F609H
F6-10	Stop DC braking time	0.0s ~ 100.0s	0.0s	F60AH
F6-11	Brake usage rate	0% ~ 100%	100%	F60BH
F6-13	JOG frequency	0.00Hz ~ maximum frequency	2.00Hz	F60DH
F6-14	JOG acceleration time	0.0s ~ 6500.0s	20.0s	F60EH
F6-15	JOG deceleration time	0.0s ~ 6500.0s	20.0s	F60FH
F6-16	Terminal JOG takes precedence	0: invalid 1: valid	0	F610H
F6-17	Acceleration time 2	0.0s ~ 6500.0s	Model determination	F611H

Function code	Name	Setting range	Factory value	Communication address
F6-18	Deceleration time 2	0s~6500.0s	Model determination	F612H
F6-19	Acceleration time 3	0s~6500.0s	Model determination	F613H
F6-20	Deceleration time 3	0s~6500.0s	Model determination	F614H
F6-21	Acceleration time 4	0s~6500.0s	Model determination	F615H
F6-22	Deceleration time 4	0s~6500.0s	Model determination	F616H
F6-23	Acceleration and deceleration mode	0: linear acceleration and deceleration 1: S curve acceleration and deceleration	0	F617H
F6-24	Proportion of time at start of S curve	0.0%~(100.0%-F6-25)	30.0%	F618H
F6-25	Proportion of time at end of S curve	0.0%~(100.0%-F6-24)	30.0%	F619H
F6-26	Acceleration time 1 and acceleration time 2 switching frequency point	0.00Hz ~ maximum frequency	0.00Hz	F61AH
F6-27	Deceleration time 1 and deceleration time 2 switching frequency point	0.00Hz ~ maximum frequency	0.00Hz	F61BH
F7 group torque control parameters				
F7-00	Speed / torque control mode selection	0: Speed control 1: torque control	0	F700H
F7-01	Torque setting and source selection under torque control mode	0: number setting 1 (F7 - 03) 1: AI1 2: AI2 3: AI3 4: PULSE pulse 5: communication given 6: MIN (AI1,AI2) 7: MAX (AI1,AI2) (full scale of option 1 - 7, corresponding to F7 - 03 digital setting)	0	F701H
F7-02	Small torque stop compensation	-50.0% ~ 50.0%	0.0%	F702H
F7-03	Torque number word setting in torque control mode	-200.0% ~ 200.0%	150.0%	F703H
F7-04	Torque control speed limit source	0: set by F7 - 05 and F7 - 06 1: set by F0 - 03 frequency source.	0	F704H
F7-05	Torque control forward speed limit	0.00Hz ~ maximum frequency	50.00Hz	F705H
F7-06	Torque control reverse speed limit	0.00Hz ~ maximum frequency	50.00Hz	F706H
F7-07	Torque rise filtering time	0.00s~650.00s	0.00s	F707H
F7-08	Torque drop filtering time	0.00s~650.00s	0.00s	F708H
F7-09	Torque control frequency rise time	0.00s~6500.0s	20.0s	F709H
F7-10	Torque control frequency drop time	0.00s~6500.0s	20.0s	F70AH
F7-11	Coefficient of friction compensation	0.0~100.0%	0.0%	F70BH
F7-10	Friction compensation time	0.00s~100.0s	3.0s	F70CH

Function code	Name	Setting range	Factory value	Communication address
F8 group auxiliary function				
F8-00	Set the cumulative power-up time	0h~65000h	0h	F800H
F8-01	Set the cumulative run time	0h~65000h	0h	F801H
F8-02	Selection of G/P machine	1: G machine 2: P machine	1	F802H
F8-04	Timing function selection	0: invalid 1: valid	0	F804H
F8-05	Timing run time selection	0: F8 - 06 settings 1: AI1 2: AI2 3: AI3 analog input range corresponds to F8 - 06	0	F805H
F8-06	Timing run time	0.0Min~6500.0Min	0.0Min	F806H
F8-07	This run is set at the arrival time	0.0~6500.0 minutes	0.0Min	F807H
F8-08	Hopping frequency 1	0.00Hz ~ maximum frequency	0.00Hz	F808H
F8-09	Hopping frequency 2	0.00Hz ~ maximum frequency	0.00Hz	F809H
F8-10	Hopping frequency 3	0.00Hz ~ maximum frequency	0.00Hz	F80AH
F8-11	Hopping frequency 4	0.00Hz ~ maximum frequency	0.00Hz	F80BH
F8-12	Amplitude of hopping frequency	0.00Hz ~ maximum frequency	0.01Hz	F80CH
F8-13	Whether the jump frequency valid during acceleration and deceleration	0: invalid 1: valid	0	F80DH
F8-14	Wakeup frequency	(F8 - 16) -the maximum frequency (F0 - 16)	0.00Hz	F80EH
F8-15	Wake - up and delay time	0.0s~6500.0s	0.0s	F80FH
F8-16	Sleep frequency	0.00Hz ~ wakeup frequency (F8 - 14)	0.00Hz	F810H
F8-17	Sleep delay time	0.0s~6500.0s	0.0s	F811H
F8-18	Output power correction factor	0.00% - 200.0%	100.0%	F812H
F8-19	Selection of instantaneous outage action	0: invalid 1: deceleration 2: slow down and shut down	0	F813H
F8-20	Momentary stop action suspends judgment of cutoff voltage	80.0%~100.0%	90.0%	F814H
F8-21	Judging time of instantaneous power failure voltage rising	0.00s~100.00s	0.50s	F815H

Function code	Name	Setting range	Factory value	Communication address
F8-22	Instantaneous power failure action judges OFF voltage	60.0 % ~ 100.0 % (standard bus voltage)	80.0%	F816H
F8-23	Pendulum frequency setting mode	0: relative to center frequency 1: relative to maximum frequency	0	F817H
F8-24	Swing amplitude	0.0% ~ 100.0%	0.0%	F818H
F8-25	Amplitude of sudden jump frequency	0.0% ~ 50.0%	0.0%	F819H
F8-26	Frequency swing period	0.1s~3000.0s	10.0s	F81AH
F8-27	Rise time of triangular wave of pendulum frequency	0.1% ~ 100.0%	50.0%	F81BH
F8-28	Set length	0m~65535m	1000m	F81CH
F8-29	Actual length	0m~65535m	0m	F81DH
F8-30	Number of pulses per meter	0.1~6553.5	100.0	F81EH
F8-31	Set the count value	1~65535	1000	F81FH
F8-32	Specify count value	1~65535	1000	F820H
F9 group failure and protection				
F9-00	Motor overload protection selection	0: prohibited 1: allowed	1	F900H
F9-01	Motor overload protection gain	0.20~10.00	1.00	F901H
F9-02	Motor overload early warning coefficient	50% ~ 100%	80%	F902H
F9-03	over voltage stall gain	0~100	30	F903H
F9-04	over voltage stall protection voltage	200.0V ~ 2000.0V	760.0V	F904H
F9-05	Over - loss rate gain	0~100	20	F905H
F9-06	Over current protection current	100% ~ 200%	150%	F906H
F9-07	Selection of short circuit protection between power-on and ground	0: invalid 1: valid	1	F907H
F9-08	Does the under voltage fault reset automatically	0: auto reset 1: not automatically reset	0	F908H
F9-09	Number of automatic fault resets	0~20	0	F909H
F9-10	Fault DO action selection during automatic fault reset period	0: no action 1: action	0	F90AH
F9-11	Time between automatic fault reset	0.1s~100.0s	1.0s	F90BH
F9-12	Input phase missing \ contactor suction protection selection	Bits: input phase loss protection selection 10 bits: contactor pull-in protection selection 0: prohibited 1: allowed	11	F90CH
F9-13	Output phase - missing protection selection	0: prohibited 1: allowed	1	F90DH

Function code	Name	Setting range	Factory value	Communication address
F9-14	Fault protection action option 1	Bits: motor overload (OL2) 0: free parking 1: shut down according to shutdown method 2: continue running 10 bits: input phase missing (IPL) 100 bits: output phase missing (OPL) 1000 bits: external fault (ETF) 10,000 bits: communication abnormality (COF)	00000	F90EH
F9-15	Fault protection action option 2	Bits: 0: free parking 10 bits: abnormal reading and writing of function code (E2F) 0: free parking 1: shut down according to shutdown method 100 bits: reserved 10,000 bits: running time arrival (rtAF)	00000	F90FH
F9-16	Fault protection action option 3	Bits: user-defined fault 1 (UEF1) 0: free parking 1: shut down according to shutdown method 2: continue running 10 bits: user-defined fault 2 (UEF2) 0: free parking 1: shut down according to shutdown method 2: continue to run 100 bits: power on time (UTF) 0: free parking 1: shut down according to the shutdown party 2: continue to run 1000 bits: OFF load (LIF) 0: free parking 1: slow down and stop 2: Jump to 7 % of the rated frequency of the motor to continue running directly, and automatically return when the load is not OFF loaded 10,000 bits: when running PID feedback loss (PIDF) 0: free parking 1: shut down according to shutdown method 2: continue running	00000	F910H
F9-17	Fault protection action option 4	Bits: excessive speed deviation (DEU) 0: free parking 1: shut down according to shutdown method 2: continue to run for 10 bits: motor over speed (OSF) 100 bits: initial position error (poF)	00000	F911H
F9-21	Continue operating frequency selection in case of failure	0: run at current operating frequency 1: run at the set frequency 2: run at the upper limit frequency 3: the following limited frequency operation 4: run at abnormal standby frequency	0	F915H
F9-22	Abnormal standby frequency	0.0 % ~ 100.0 % (100.0 % corresponding to the maximum frequency F0 - 16)	100.0%	F916H
F9-23	Motor sensor type	0: none 1: PT100 2: PT1000	0	F917H
F9-24	Motor overheating threshold	0°C ~ 200°C	110	F918H
F9-25	Motor overheating warning threshold	0°C ~ 200°C	90	F919H

Function code	Name	Setting range	Factory value	Communication address
F9-26	Off - load protection option	0: invalid 1: valid	0	F91AH
F9-27	Load shedding test level	0.0~100.0%	10.0%	F91BH
F9-28	Off loading test time	0.0~60.0s	1.0s	F91CH
F9-30	Over - speed detection value	0.0 % ~ 50.0 % (the maximum frequency)	20.0%	F91EH
F9-31	Over - speed test time	0.0s: not tested 0.1~60.0s	1.0s	F91FH
F9-32	Excessive speed deviation test value	0.0 % ~ 50.0 % (the maximum frequency)	20.0%	F920H
F9-33	Excessive speed deviation inspection time	0.0s: not tested 0.1~60.0s	5.0s	F921H
FA group PID function				
FA-00	PID given source	0: FA - 01 settings 1: AI1 2: AI2 3: AI3 4: PULSE pulse setting (X5) 5: Communication given 6: Multi-segment instruction given 7: FA-01 setting (up/down can be changed)	0	FA00H
FA-01	PID value given	0.0% - 100.0%	50.0%	FA01H
FA-02	PID feedback source	0: AI1 1: AI2 2: AI3 3: AI1-AI2 4: PULSE pulse setting (X5) 5: communication given 6: AI1+AI2 7: MAX (AI1 , AI2) 8: MIN (AI1 , AI2)	0	FA02H
FA-03	PID direction of action	0: positive effect 1: reaction	0	FA03H
FA-04	PID given feedback range	10~65535	1000	FA04H
FA-05	Proportional gain Kp	0.0~100.0	20.0	FA05H
FA-06	Integration time Ti	0.01s~10.00s	2.00s	FA06H
FA-07	Differential time Td	0.000s~10.000s	0.000s	FA07H
FA-08	PID inversion cutoff frequency	0.00 ~ maximum frequency	0.00Hz	FA08H
FA-09	PID deviation limit	0.0%~100.0%	0.0%	FA09H
FA-10	PID differential limiting	0.00%~100.00%	0.10%	FA0AH
FA-11	PID given change time	0.00~650.00s	0.00s	FA0BH
FA-12	PID feedback filtering time	0.00~60.00s	0.00s	FA0CH
FA-13	PID output filtering time	0.00~60.00s	0.00s	FA0DH
FA-15	Proportional gain Kp	0.0~100.0	20.0	FA0FH

Function code	Name	Setting range	Factory value	Communication address
FA-16	Integration time Ti	0.01s~10.00s	2.00s	FA10H
FA-17	Differential time Td	0.000s~10.000s	0.000s	FA11H
FA-18	PID parameter switching condition	0: do not switch 1: switch through X terminal 2: switch automatically according to deviation 3: automatically switch according to operating frequency	0	FA12H
FA-19	Deviation of PID parameter switching	0.0%~FA-20	20.0%	FA13H
FA-20	PID parameter switching offset 2	FA-19~100.0%	80.0%	FA14H
FA-21	Initial PID value	0.0%~100.0%	0.0%	FA15H
FA-22	Initial PID value holding time	0.00~650.00s	0.00s	FA16H
FA-23	Positive maximum of two output deviations	0.00%~100.00%	1.00%	FA17H
FA-24	Maximum reverse output deviation for two times	0.00%~100.00%	1.00%	FA18H
FA-25	PID integral attribute	Bits: integral separation 0: invalid 1: valid 10 bits: stop integrating after output to limit value 0: continue integrating 1: stop points	00	FA19H
FA-26	PID feedback missing test value	0.0 %: loss of feedback without judgment 0.1% - 100.0%	0.0%	FA1AH
FA-27	PID feedback loss detection time	0.0s~20.0s	0.0s	FA1BH
FA-28	PID shutdown operation	0: stop without calculation 1: calculation during shutdown	0	FA1CH
FA-29	Stress wake-up option	0: do not wake up under pressure 1: wake up under pressure	0	FA1DH
FA-30	Percentage of wake-up pressure	50%~1000%	80.0%	FA1EH
FA-31	Pressure wake-up delay time	0.0~6000.0s	1.0	FA1FH
FA-32	Percentage of dormant pressure	0: 100.0%	100.0%	FA20H
FA-33	Pressure sleep delay time	0.0~6000.0s	60.0S	FA21H
FB group second group motor parameters				
FB-01	Rated power of asynchronous motor	0.1kW~6553.5kW	Model determination	FB01H
FB-02	Rated voltage of motor	1V~2000V	Model determination	FB02H

Function code	Name	Setting range	Factory value	Communication address
FB-03	Rated current of motor	0.01A ~ 655.35A (frequency inverter power ≤ 55kW) 0.1A ~ 6553.5A (frequency inverter work rate > 55kW)	Model determination	FB03H
FB-04	Rated frequency of motor	0.01Hz ~ maximum frequency	Model determination	FB04H
FB-05	Rated speed of motor	1rpm~65535rpm	Model determination	FB05H
FB-06	Stator resistance of asynchronous motor	0.001~65.535 (frequency inverter power ≤ 55kW) 0.0001 ~ 6.5535 (frequency inverter power > 55kW)	Model determination	FB06H
FB-07	Rotor resistance of asynchronous motor	0.001~65.535 (frequency inverter power ≤ 55kW) 0.0001 ~ 6.5535 (frequency inverter power > 55kW)	Model determination	FB07H
FB-08	Induction motor leakage reactance	0.01 mH ~ 655.35 mH(frequency inverter power ≤ 55kW) 0.001 mH ~ 65.535 mH (frequency inverter power > 55kW)	Model determination	FB08H
FB-09	Mutual inductance reactance of asynchronous motor	0.1 mH ~ 6553.5 mH(frequency inverter power ≤ 55kW) 0.01 mH ~ 655.35 mH (frequency inverter power > 55kW)	Model determination	FB09H
FB-10	Asynchronous motor no-load current	0.01A~FB-03(frequency inverter power ≤ 55kW)0.1A~FB-03 (frequency inverter power > 55kW)	Model determination	FB0AH
FB-29	Tuning selection	0: no operation 1: asynchronous machine static tuning 2. asynchronous machine fully tuned	0	FB1DH
FB-38	Velocity loop proportional gain KP1	1~100	30	FB26H
FB-39	Speed loop integral gain KI1	0.01s~10.0s	0.50s	FB27H
FB-40	Switching frequency 1	0.00~FB-43	5.00Hz	FB28H
FB-41	Velocity loop proportional gain KP2	1~100	20	FB29H
FB-42	Speed loop integral gain KI2	0.01s~10.00s	1.00s	FB2AH
FB-43	Switching frequency 2	FB-40~maximum frequency	10.00Hz	FB2BH
FB-44	Vector controlled slip gain	50%~200%	100%	FB2CH
FB-45	SVC torque filter constant	00~31	0.000s	FB2DH

Function code	Name	Setting range	Factory value	Communication address
FB-47	Torque upper limit source under speed control mode	0: FB - 48 settings 1: AI1 2: AI2 3: AI3 4: PULSE pulse 5: communication given 6: MIN (AI1,AI2) 7: Full scale of 7: MAX (AI1, AI2)1-7 option, corresponding to FB-48 digital setting	0	FB2FH
FB-48	Numerical setting of upper limit of torque under speed control mode	0.0%~200.0%	150.0%	FB30H
FB-51	Excitation regulation proportional gain	0~60000	2000	FB33H
FB-52	Excitation regulation integral gain	0~60000	1300	FB34H
FB-53	Torque adjusting proportional gain	0~60000	2000	FB35H
FB-54	Torque adjusting integral gain	0~60000	1300	FB36H
FB-55	Integral property of velocity loop	Bits: integral separation 0: invalid 1: valid	0	FB37H
FB-61	Second motor control mode	0: no PG open loop vector control 1: PG closed loop vector control 2: V/F control	0	FB3DH
FB-62	Selection between acceleration and deceleration of 2nd motor	0: same as 1st motor 1: acceleration and deceleration time 1 2: acceleration and deceleration time 2 3: acceleration and deceleration time 3 4: acceleration and deceleration time 4	0	FB3EH
FB-63	Second motor torque boost	0.0 %: automatic torque increase 0.1%~30.0%	Model determination	FB3FH
FB-65	Second motor oscillation suppression gain	0~100	Model determination	FB41H
FC group multi-segment instruction, simple PLC				
FC-00	Multi - segment instruction 0	-100.0%~100.0%	0.0%	FC00H
FC-01	Multi - segment instruction 1	-100.0%~100.0%	0.0%	FC01H
FC-02	Multi - segment instruction 2	-100.0%~100.0%	0.0%	FC02H
FC-03	Multi - segment instruction 3	-100.0%~100.0%	0.0%	FC03H
FC-04	Multi - segment instruction 4	-100.0%~100.0%	0.0%	FC04H
FC-05	Multi - segment instruction 5	-100.0%~100.0%	0.0%	FC05H
FC-06	Multi - segment instruction 6	-100.0%~100.0%	0.0%	FC06H
FC-07	Multi - segment instruction 7	-100.0%~100.0%	0.0%	FC07H

Function code	Name	Setting range	Factory value	Communication address
FC-08	Multi - segment instruction 8	-100.0%~100.0%	0.0%	FC08H
FC-09	Multi - segment instruction 9	-100.0%~100.0%	0.0%	FC09H
FC-10	Multi - segment instruction 10	-100.0%~100.0%	0.0%	FC0AH
FC-11	Multi - segment instruction 11	-100.0%~100.0%	0.0%	FC0BH
FC-12	Multi - segment instruction 12	-100.0%~100.0%	0.0%	FC0CH
FC-13	Multi - segment instruction 13	-100.0%~100.0%	0.0%	FC0DH
FC-14	Multi - segment instruction 14	-100.0%~100.0%	0.0%	FC0EH
FC-15	Multi - segment instruction 15	-100.0%~100.0%	0.0%	FC0FH
FC-16	Simple PLC operation mode	0: stop after single operation 1: maintain final value at end of single run 2: keep circulating	0	FC10H
FC-17	Simple PLC power failure memory option	Bits: power failure memory option 0: no memory when power fails 1: memory when power fails 10 bits: stop memory option 0 for shutdown memory 1: stop memory	00	FC11H
FC-18	Simple PLC section 0 shipping time	0.0s(h)~6500.0s(h)	0.0s(h)	FC12H
FC-19	Selection of acceleration and deceleration time for simple PLC section 0	0~3	0	FC13H
FC-20	Simple PLC section 1 shipping time	0.0s(h)~6500.0s(h)	0.0s(h)	FC14H
FC-21	Selection of acceleration and deceleration time for simple PLC section 1	0~3	0	FC15H
FC-22	Simple PLC section 2 shipping time	0.0s(h)~6500.0s(h)	0.0s(h)	FC16H
FC-23	Selection of acceleration and deceleration time for simple PLC section 2	0~3	0	FC17H
FC-24	Simple PLC section 3 shipping time	0.0s(h)~6500.0s(h)	0.0s(h)	FC18H
FC-25	Selection of acceleration and deceleration time for simple PLC section 3	0~3	0	FC19H
FC-26	Simple PLC section 4 shipping time	0.0s(h)~6500.0s(h)	0.0s(h)	FC1AH
FC-27	Selection of acceleration and deceleration time for simple PLC section 4	0~3	0	FC1BH
FC-28	Simple PLC section 5 shipping time	0.0s(h)~6500.0s(h)	0.0s(h)	FC1CH
FC-29	Selection of acceleration and deceleration time for simple PLC section 5	0~3	0	FC1DH

Function code	Name	Setting range	Factory value	Communication address
FC-30	Simple PLC section 6 shipping time	0.0s(h)~6500.0s(h)	0.0s(h)	FC1EH
FC-31	Selection of acceleration and deceleration time for simple PLC section 6	0~3	0	FC1FH
FC-32	Simple PLC section 7 shipping time	0.0s(h)~6500.0s(h)	0.0s(h)	FC20H
FC-33	Selection of acceleration and deceleration time for simple PLC section 7	0~3	0	FC21H
FC-34	Simple PLC section 8 shipping time	0.0s(h)~6500.0s(h)	0.0s(h)	FC22H
FC-35	Selection of acceleration and deceleration time for simple PLC section 8	0~3	0	FC23H
FC-36	Simple PLC section 9 shipping time	0.0s(h)~6500.0s(h)	0.0s(h)	FC24H
FC-37	Selection of acceleration and deceleration time for simple PLC section 9	0~3	0	FC25H
FC-38	Simple PLC section 10 shipping time	0.0s(h)~6500.0s(h)	0.0s(h)	FC26H
FC-39	Selection of acceleration and deceleration time for simple PLC section 10	0~3	0	FC27H
FC-40	Simple PLC section 11 shipping time	0.0s(h)~6500.0s(h)	0.0s(h)	FC28H
FC-41	Selection of acceleration and deceleration time for simple PLC section 11	0~3	0	FC29H
FC-42	Simple PLC section 12 shipping time	0.0s(h)~6500.0s(h)	0.0s(h)	FC2AH
FC-43	Selection of acceleration and deceleration time for simple PLC section 12	0~3	0	FC2BH
FC-44	Simple PLC section 13 shipping time	0.0s(h)~6500.0s(h)	0.0s(h)	FC2CH
FC-45	Selection of acceleration and deceleration time for simple PLC section 13	0~3	0	FC2DH
FC-46	Simple PLC section 14 shipping time	0.0s(h)~6500.0s(h)	0.0s(h)	FC2EH
FC-47	Selection of acceleration and deceleration time for simple PLC section 14	0~3	0	FC2FH
FC-48	Simple PLC section 15 shipping time	0.0s(h)~6500.0s(h)	0.0s(h)	FC30H
FC-49	Selection of acceleration and deceleration time for simple PLC section 15	0~3	0	FC31H
FC-50	Simple PLC runtime unit	0: S (seconds) 1: h (hours)	0	FC32H

Function code	Name	Setting range	Factory value	Communication address
FC-51	Given mode of multi-segment instruction 0	0: given function code FC - 00 1: AI1 2: AI2 3: AI3 4: PULSE pulse 5: PID 6: Given the preset frequency (F 0-09), UP/DOWN can be modified 7: the direct selection frequency of the terminal is multi-segment digital source	0	FC33H
FD group communication parameters				
FD-00	Communication protocol selection	0: MODBUS protocol 1: PROFIBUS	0	FD00H
FD-01	Communication baud rate	Bit: Modbus wave frequency 0: 300 bps 1: 600BPS 2: 1200BPS 3: 2400BPS 4: 4800BPS 5: 9600BPS 6: 19200BPS 7: 38400BPS 8: 57600BPS 9: 115200BPS	5005	FD01H
FD-02	MODBUS data format	0: no check (8 -N-2) 1: even check (8-E-1) 2: odd check (8-O-1) 3: no check (8-N-1)	0	FD02H
FD-03	Local address	0: broadcast address 1~247	1	FD03H
FD-04	MODBUS response delay	0~20ms	2	FD04H
FD-05	Communication timeout	0.0: invalid 0.1~60.0s	0.0	FD05H
FD-06	MODBUS communication data format	Bits: MODBUS 0: non-standard MODBUS protocol 1: standard MODBUS protocol Ten bits: reserved.	31	FD06H
FD-07	Discrimination rate of communication read current	0: 0.01A 1: 0.1A	0	FD07H
FD-08	Communication setting frequency selection	Bit: 0: percentage of maximum frequency 1: set frequency directly Ten bits: reserved.	0	FD08H
FD-09	Return data selection	0: send back frame after receiving data 1: do not send back frames after receiving data	0	FD09H
FE group user customized function code				
FE-00	User function code 0	F0-00~FH-xx P0-00~Px-xx U0-xx~U0-xx	F0-00	FE00H
FE-01	User function code 1		F0-00	FE01H
FE-02	User function code 2		F0-00	FE02H
FE-03	User function code 3		F0-00	FE03H
FE-04	User function code 4		F0-00	FE04H
FE-05	User function code 5		F0-00	FE05H

Function code	Name	Setting range	Factory value	Communication address
FE-06	User function code 6		F0-00	FE06H
FE-07	User function code 7		F0-00	FE07H
FE-08	User function code 8		F0-00	FE08H
FE-09	User function code 9		F0-00	FE09H
FE-10	User function code 10		F0-00	FE0AH
FE-11	User function code 11		F0-00	FE0BH
FE-12	User function code 12		F0-00	FE0CH
FE-13	User function code 13		F0-00	FE0DH
FE-14	User function code 14		F0-00	FE0EH
FE-15	User function code 15		F0-00	FE0FH
FE-16	User function code 16		F0-00	FE10H
FE-17	User function code 17		F0-00	FE11H
FE-18	User function code 18		F0-00	FE12H
FE-19	User function code 19		F0-00	FE13H
FE-20	User function code 20		F0-00	FE14H
FE-21	User function code 21		F0-00	FE15H
FE-22	User function code 22		F0-00	FE16H
FE-23	User function code 23		F0-00	FE17H
FE-24	User function code 24		F0-00	FE18H
FE-25	User function code 25		F0-00	FE19H
FE-26	User function code 26		F0-00	FE1AH
FE-27	User function code 27		F0-00	FE1BH
FE-28	User function code 28		F0-00	FE1CH
FE-29	User function code 29		F0-00	FE1DH
FF group performance optimization parameters				
FF-04	Cbc current limiting enable	0: not enabled 1: enable	1	FF04H
FF-06	Under voltage point setting	200.0V~2000.0V	350.0V	FF06H
FF-09	over voltage point setting	200.0V~2200.0V	Model determination	FF09H

Function code	Name	Setting range	Factory value	Communication address
FF-10	Over current suppression starting current	50%~200.0%	150%	FF0AH
FF-11	Over current suppression enable	0: not suppressed 1: inhibition enable	1	FF0BH
FF-12	Post stall suppression gain	0~100	20	FF0CH
FF-13	Over current suppression current compensation coefficient	50%~200.0%	50%	FF0DH
FF-14	over voltage suppression starting voltage	650.0V~800.0V	760V	FF0EH
FF-15	over voltage suppression enable	0: not suppressed 1: inhibition enable	1	FF0FH
FF-16	over voltage suppression frequency gain	0~100	30	FF10H
FF-17	over voltage suppression voltage gain	0~100	30	FF11H
FF-18	over voltage suppression maximum rise limit frequency	0~50Hz	5Hz	FF12H
FF-19	Slip compensation coefficient	0.1~10.0	0.5	FF13H
FF-20	Automatic frequency up enable	0: not enabled 1: enable	0	FF14H
FF-21	Minimum electric torque current	10~100	50	FF15H
FF-22	Maximum generating torque current	10~100	20	FF16H
FF-23	Automatic frequency increase KP	0~100	50	FF17H
FF-24	Automatic frequency increase KI	0~100	50	FF18H
FF-26	Rotational speed tracking proportional gain KP	0~1000	500	FF1AH
FF-27	Rotational speed tracking integral gain KI	0~1000	800	FF1BH
FF-28	Rotational speed tracking target current	30~200	100	FF1CH
FF-29	Lower limit of rotational speed tracking current	10~100	30	FF1DH
FF-30	Rotational speed tracking voltage rise time	0.5~30s	1.1s	FF1EH
FF-31	Demagnetization time	0.00~5.00s	1.00s	FF1FH
FF-32	Starting voltage of brake unit	650~800V	690V	FF20H
FF-33	Instantaneous stop gain	0~100	40	FF21H
FF-34	Instant stop gain	0~100	30	FF22H
FF-35	Deceleration time for momentary stop	0.0~300.0s	5.0	FF23H
FF-36	Instant stop function selection	0: invalid 1: slow down but do not stop 2: slow down to stop	0	FF24H
FF-37	Instantaneous stop recovery judgment voltage	80: 100%	85%	FF25H
FF-38	Judging time for instantaneous stop and non-stop voltage recovery	0.0~100.0s	0.5s	FF26H
FF-39	Judging time for instantaneous stop and non-stop movement	60%~100%	80%	FF27H

Function code	Name	Setting range	Factory value	Communication address
E0 group fault record group				
E0-00	First failure type	0: no fault 1: reservations 2: accelerating over current 3: slow down over current 4: constant speed over current 5: accelerating over voltage 6: deceleration over voltage 7: constant speed over voltage 8: buffer resistance overload 9: under voltage 10: frequency inverter overload 11: motor overload 12: enter missing phase 13: output phase missing 14: module overheating 15: external failure 16: abnormal communication 17: contactor abnormal 18: abnormal current detection 19: abnormal motor tuning 20: encoder /PG card exception 21: abnormal reading and writing of parameters 22: abnormal frequency inverter hardware 23: motor short circuit to ground 24: reservations 25: reservations 26: the running time has arrived 27: User - defined fault 1 28: User - defined fault 2 29: Time to power on 30: OFF load 31: loss of PID feedback at runtime 40: fast current limit timeout 41: switch the motor during operation 42: Speed deviation is too large 43: motor over speed 45: motor over temperature 51: incorrect initial position	-	AF00H
E0-01	Second failure type		-	AF01H
E0-02	Third (most recent) failure type		-	AF02H
E0-03	Frequency of third (most recent) failure	-	-	AF03H
E0-04	Current at the third (most recent) fault	-	-	AF04H
E0-05	Bus voltage at the third (most recent) fault	-	-	AF05H
E0-06	Enter the terminal status for the third (most recent) failure	-	-	AF06H

Function code	Name	Setting range	Factory value	Communication address
E0-07	Output terminal at the third (most recent) failure	-	-	AF07H
E0-08	Frequency inverter status at the third (most recent) failure	-	-	AF08H
E0-09	Power on time for the third (most recent) failure	-	-	AF09H
E0-10	Run time at the third (most recent) failure	-	-	AF0AH
E0-11	Radiator temperature at third failure	-	-	AF0BH
E0-13	Frequency at second failure	-	-	AF0DH
E0-14	Current at second failure	-	-	AF0EH
E0-15	Bus voltage at second failure	-	-	AF0FH
E0-16	Enter the terminal status during the second failure	-	-	AF10H
E0-17	Output terminal status at second failure	-	-	AF11H
E0-18	Frequency inverter status at second failure	-	-	AF12H
E0-19	Power on time for second failure	-	-	AF13H
E0-20	Run time at second failure	-	-	AF14H
E0-21	Radiator temperature at the second failure	-	-	AF15H
E0-23	Frequency at first failure	-	-	AF17H
E0-24	Current at first failure	-	-	AF18H
E0-25	Bus voltage at first failure	-	-	AF19H
E0-26	Enter the terminal status when the fault occurs for the first time.	-	-	AF1AH
E0-27	Output terminal status at first failure	-	-	AF1BH
E0-28	Frequency inverter status at first failure	-	-	AF1CH
E0-29	Power on time for first failure	-	-	AF1DH
E0-30	Run time at first failure	-	-	AF1EH
E0-31	Radiator temperature at the first failure	-	-	AF1FH
P2 group AIA correction group				
P2-00	A11 measured voltage 1	-10.00V~10.00V	Factory correction	A200H
P2-01	A11 displayed voltage 1	-10.00V~10.00V	Factory correction	A201H

Function code	Name	Setting range	Factory value	Communication address
P2-02	AI1 measured voltage 2	-10.000V~10.000V	Factory correction	A202H
P2-03	AI1 displayed voltage 2	-10.000V~10.000V	Factory correction	A203H
P2-04	AI2 measured voltage 1	-10.000V~10.000V	Factory correction	A204H
P2-05	AI2 displayed voltage 1	-10.000V~10.000V	Factory correction	A205H
P2-06	AI2 measured voltage 2	-10.000V~10.000V	Factory correction	A206H
P2-07	AI2 displayed voltage 2	-10.000V~10.000V	Factory correction	A207H
P2-08	AI3 measured voltage 1	-10.000V~10.000V	Factory correction	A208H
P2-09	AI3 displayed voltage 1	-10.000V~10.000V	Factory correction	A209H
P2-10	AI3 measured voltage 2	-10.000V~10.000V	Factory correction	A20AH
P2-11	AI3 displayed voltage 2	-10.000V~10.000V	Factory correction	A20BH

4.2 Summary table of monitoring parameters

Function code	Name	Minimum unit	Communication address
U0 group basic monitoring parameters			
U0-00	Operating frequency (Hz)	0.01Hz	7000H
U0-01	Set frequency (Hz)	0.01Hz	7001H
U0-02	Busbar voltage (V)	0.1V	7002H
U0-03	Output voltage (V)	1V	7003H
U0-04	Output current (A)	0.01A	7004H
U0-05	Output power (kW)	0.1kW	7005H
U0-06	Output torque (%)	0.1%	7006H
U0-07	X terminal input status	1	7007H
U0-08	Do output state	1	7008H
U0-09	AI1 voltage (V)	0.01V	7009H
U0-10	AI2 voltage (V) / current (mA)	0.01V/0.01mA	700AH
U0-11	AI3 voltage (V)	0.01V	700BH
U0-12	count value	1	700CH
U0-13	Length value	1	700DH
U0-14	Load speed display	1	700EH
U0-15	PID setting	1	700FH
U0-16	PID feedback	1	7010H
U0-17	PLC stage	1	7011H
U0-18	PULSE input pulse frequency (Hz)	0.01kHz	7012H
U0-19	Feedback speed (Hz)	0.01Hz	7013H
U0-20	Remaining operating time	0.1Min	7014H
U0-21	AI1 pre-correction voltage	0.001V	7015H
U0-22	AI2 voltage before correction (V) / current (mA)	0.001V/0.01mA	7016H
U0-23	AI3 voltage before correction	0.001V	7017H
U0-24	Linear velocity	1m/Min	7018H
U0-25	Current power-on time	1Min	7019H
U0-26	Current run time	0.1Min	701AH
U0-27	PULSE input pulse frequency	1Hz	701BH
U0-28	communication set value	0.01%	701CH

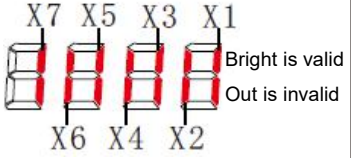
Function code	Name	Minimum unit	Communication address
U0-30	Main frequency X display	0.01Hz	701EH
U0-31	Secondary frequency Y display	0.01Hz	701FH
U0-32	View any memory address values	1	7020H
U0-34	Motor temperature value	1°C	7022H
U0-35	Target torque (%)	0.1%	7023H
U0-37	Power factor angle	0.1°	7025H
U0-39	VF separates target voltage	1V	7027H
U0-40	VF separates output voltage	1V	7028H
U0-41	X input status visual display		7029H
U0-42	DO input status visual display	1	702AH
U0-45	Fault message	1	702DH
U0-59	Set frequency (%)	0.01%	703BH
U0-60	Operating frequency (%)	0.01%	703CH
U0-61	frequency inverter status	1	703DH
U0-62	Current fault code	1	703EH
U0-65	Upper torque limit	0.1%	7041H
U0-69	frequency inverter module radiator temperature	0°C~120°C	7045H
U0-70	Accumulated operating time	0h~65535h	7046H
U0-71	Cumulative power-on time	0~65535 hours	7047H
U0-72	Cumulative power consumption	0 ~ 65535 degrees	7048H
U0-73	Product Number	-	7049H
U0-74	Software version number	-	704AH
U0-76	Rated power of frequency converter	0.1KW	704CH
U0-77	frequency inverter G/P type machine	1	704DH
U0-78	Rated voltage of frequency inverter	1V	704EH

Chapter V Description of parameters

In this chapter:

FX-XX	YYYYYY	N1~N2	[D]
(function cod)	(function code name)	(function code range)	(default)

F0 Group basic function group

F0 - 00 menu display selection	0~11 [11]
--------------------------------	-----------

00: only f group parameters are displayed.

01: display f group and u group parameters.

11: display parameters of group f, group p, and group u.

F0 - 01 motor control mode selection	0~2 [2]
--------------------------------------	---------

0: no PG open loop vector control

Refers to open-loop vector control, which is suitable for common high-performance control occasions. And a frequency inverter can only drive one electric machine. Such as machine tools, centrifuges, wire drawing machines, injection molding machines, etc.

1: PG closed loop vector control

2: V/F control

It is suitable for occasions where the load requirement is not high, or one frequency inverter drives multiple motors, such as negative load of fans and pumps. For occasions where one frequency inverter drives multiple motors

Tips:

The motor parameter identification process must be carried out when selecting the vector control mode. Only accurate motor parameters can give rise to the advantages of vector control. Better performance can be obtained by adjusting the speed regulator parameter F2 group of function codes.

F0 - 02 command given way	0~2 [0]
---------------------------	---------

0: operation panel command channel ("LOCAL/REMOT" light goes out);

The run command is controlled by the RUN, STOP/RES keys on the operation panel.

1: terminal command channel ("LOCAL/REMOT" light on);

The multifunctional input terminals FWD, REV, JOGF, JOGR, etc. control the operation command.

2: the communication command channel ("LOCAL/REMOT" light flashes)

Operation command is given by the upper computer through communication.

Write the control command through address 0x2000. See appendix A for the definition of the control command.

F0 - 03 Main frequency source X selection	0~9 [1]
---	---------

0: Digital setting (no memory when power fails)

The initial value of the set frequency is F0 - 09 " preset frequency". The setting frequency value of the frequency inverter can be changed through the knob of the keyboard (or up and down of the multi-function input terminal).

When the frequency inverter is powered down and powered on again, the set frequency value returns to F0 - 09 " digital set preset frequency" value.

1: Digital setting (power failure memory)

The initial value of the set frequency is F0 - 09 " preset frequency". The setting frequency value of the frequency inverter can be changed through the knob of the keyboard (or up and down of the multi-function input terminal).When the frequency inverter is powered down and powered up again, the set frequency is the set frequency at the time of the last power down, and is memorized through the knob or the correction amount of terminals up and down.

It should be noted that F0 - 26 is "digital set frequency stop memory selection" and F0 - 26 is used to select whether the frequency correction is memorized or cleared when the frequency inverter is stopped. F0 - 26 is related to shutdown, not to power-down memory. Attention should be paid in application.

2: AI1

3: AI2

4: AI3

Where:

AI1 is a 0v - 10v voltage type input

AI2 can be a 0v - 10v voltage input or a 4ma - 20ma current input. The j8 jumper on the control panel selects AI3 as a 0v - 10v voltage.

The input voltage values of AI1, AI2, and AI3 correspond to the target frequency and can be freely selected by the user.

HV610 provides 5 groups of correspondence curves, and F5 group function codes are set.

AI is given as frequency, and the voltage / current input corresponds to 100.0 % set, which is the percentage ratio of F0 - 16 relative to the maximum frequency.

5. Pulse given (X5)

Frequency is given through terminal X5 high speed pulse.

Pulse given signal specification: voltage range 9V~30V, frequency range 0kHz~100kHz. Pulse given can only be input from the multifunctionality input terminal X5.

The relationship between the X5 terminal input pulse frequency and the corresponding setting is set through F5-13~F5-17. The corresponding relationship is a linear correspondence of 2 bits. The 100.0 % set corresponding to the pulse input refers to the percentage of the relative maximum frequency F0 - 16.

6. When selecting a multi-segment instruction

Operation mode for a multi-segment instruction, different combinations of States of the Xi terminal need to be input through a digital quantity. The corresponding the different set frequency value. HV610 can be provided with 4 multi-segment command terminals (terminal functions 12 - 15). The 16 States of 4 terminals can correspond to any 16 " multi-segment commands" through FC group function codes. The "multi-segment commands" are the percentage of the relative maximum frequency F0 - 16.

When digital quantity input X terminal is used as multi-segment command terminal function, corresponding settings need to be made in F5 group. Please refer to F5 group related function parameter description for details.

7. When the simple PLC

Frequency source is a simple PLC, the operation frequency source of the frequency converter can be switched between 1 to 16 arbitrary frequency commands. The holding time of 1~16 frequency commands and the respective acceleration and deceleration time can also be set by the user. For details, please refer to FC group's relevant instructions.

8. PID

The output of process PID control is selected as the operating frequency. It is generally used in field closed-loop control of process, such as constant pressure closed-loop control and constant tension closed-loop control.

When applying PID as the frequency source, the relevant parameters of FA group "PID function" need to be set.

9. Communication given

Refers to the frequency given by the communication method

The upper computer gives the data through the communication address 0x1000. The data format is -100.00 %~100.00 %, and 100.00 % refers to the percentage of the maximum frequency F0 - 16.

F0 - 04 Reverse control prohibited	0~1 [0]
------------------------------------	---------

0: motor allows reverse rotation

1: the motor is not allowed to reverse.

In fact, negative frequency is prohibited. When reverse operation is prohibited and reverse operation is prohibited, the frequency inverter keeps running at 0 Hz.

F0 - 04 = 1 should be set when the motor is not allowed to rotate reversely.

F0 - 05 phase sequence direction	0~1 [0]
----------------------------------	---------

0: standard phase sequence.

1: carry out phase sequence exchange. (The direction of rotation of the motor changes)

F0 - 06 start protection selection	0~1 [0]
------------------------------------	---------

0: start unprotects. As long as there is a start command and there is no fault, the frequency inverter will output and run.

1: start protection.

If the operation command of the frequency inverter is valid at power-up time (for example, the terminal operation command is closed before power - up), then the frequency inverter will not respond to the operation command, You must remove the operation command once before the frequency inverter responds.

If the operation command is valid at the time of frequency inverter fault reset and the frequency inverter does not respond to the operation command, the operation command must be removed before the operation protection state can be eliminated.

It can prevent the danger caused by the motor responding to the operation command when the motor is powered on or when the fault is reset without knowing.

F0 - 07 JOG. K key function selection	0~4 [0]
---------------------------------------	---------

The JOG.K key is a multi-function key. The function of the JOG.K key can be set through this function code. This key can be used to switch between shutdown and operation.

0: this key has no function.

1: keyboard command and remote operation switch. It refers to the switch of command source, that is, the switch between current command source and keyboard control (local operation). If the current command source is keyboard - controlled, this key function is invalid.

2: forward and reverse switching

Switches the direction of the frequency command through the jog. K key This function is only valid when the command source is the command channel of the operation panel.

3: forward jog through

Keyboard jog. K key to realize forward jog (FJOG).

4: reverse jog through

Keyboard jog. K key to realize reverse jog (RJOG).

F0 - 08 stop / reset key function selection	0~4 [1]
---	---------

0: STOP / RES key stop function is valid only in keyboard operation mode.

1: STOP / RES key stop function is valid under any operation mode

F0 - 09 preset frequency	0.00 ~ maximum frequencies [50.00 Hz]
--------------------------	---------------------------------------

When the frequency source is selected as "digital setting" or "terminal UP/DOWN", this function code value is the initial value for the frequency rate digital setting of the frequency inverter.

F0 - 10 acceleration time 1	0 ~ 65000 S [model determination]
F0 - 11 deceleration time 1	0 ~ 65000 S [model determination]

The acceleration time refers to the time required for the frequency inverter to accelerate from zero frequency to the acceleration and deceleration reference frequency (F0 - 13 is determined), as shown in figure 5 - 1, t1.

Deceleration time refers to the time required for the frequency inverter to decelerate to zero frequency from the acceleration and deceleration reference frequency (F0 - 13), as shown in figure 5 - 1, t2.

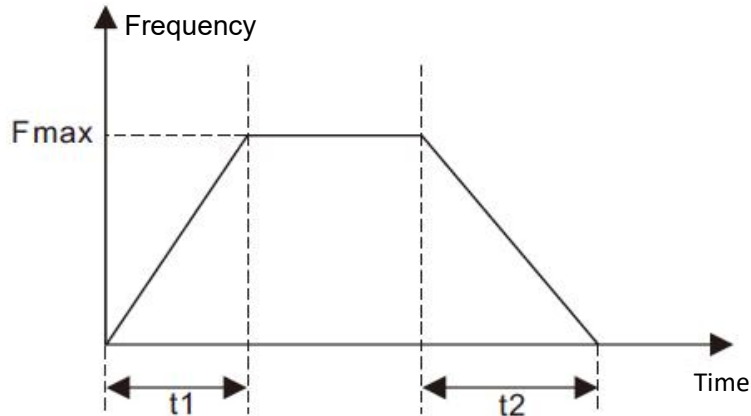

Figure 5 - 1 schematic diagram of acceleration and deceleration time

HV610 defines a total of 4 groups of acceleration and deceleration times. The user can use the digital input terminal X to switch between selections. The four groups of acceleration and deceleration times are set by the following function codes:

Group 1: F0 - 10, F0 - 11; Group 2: F6 - 17, F6 - 18;

Group iii: F6 - 19, F6 - 20; Group 4: F6 - 21, F6 - 22.

F0 - 12 acceleration / deceleration time unit	0~2 [1]
---	---------

0: the time unit is 1s.

1: the unit of time is 0.1 s.

2: the unit of time is 0.01 s.

Notes:

When modifying this function parameter, the number of decimal points displayed in the four groups of acceleration and deceleration times will change, and the corresponding acceleration and deceleration times will also change. Special attention should be paid to this during application.

F0 - 13 acceleration and deceleration time reference frequency	0~2 [0]
--	---------

0: the reference frequency is the maximum frequency (F0 - 16)

1: set the frequency at the reference frequency.

When F0 - 13 is selected as 1, the acceleration and deceleration time is related to the set frequency. If the set frequency changes frequently, the acceleration of the motor will change. Attention should be paid when applying.

2: 100 Hz at reference frequency.

F0 - 14 shutdown mode	0~1 [0]
-----------------------	---------

0: after the deceleration

Stop command is valid, the frequency inverter will reduce the output frequency according to the deceleration time, and stop after the frequency is reduced to 0.

1: after the free

Stop command is valid, the frequency inverter will terminate the output immediately. At this time, the motor will stop freely according to the mechanical inertia.

F0 - 15 droop control rate	0~10.00hz [0.00hz]
----------------------------	--------------------

The droop rate allows for a slight speed difference between the master station and the slave station, thus avoiding the rush between them. The default value for this parameter is 0.

Only when the main engine and the slave engine adopt the speed control mode will the droop rate need to be adjusted. For each transmission process, the appropriate droop rate needs to be gradually found in practice. It is recommended not to set F0 - 15 too large, otherwise the steady-state speed will drop significantly when the load is large. Both the master and slave must set the droop rate.

Droop speed = synchronous frequency * output torque * (droop rate / 10)

For example: F0 - 15 = 1.00

50 Hz synchronous frequency rate, 50 % output torque, real frequency rate of frequency changer = 50 Hz – 50 * (50 %) (1.00/10) = 47.5hz

F0 - 16 maximum frequencies	50.00~500.00hz [50.00hz]
-----------------------------	--------------------------

The analog input, pulse input (X5), multi-segment instruction, etc. are all 100.0 % of the respective calibration of F0 - 16 when they are used as frequency sources.

F0 - 17 upper frequency sources	0~5 [0]
---------------------------------	---------

0: set by F0 - 18.

1: set by analog AI1.

2: set by analog AI2.

3: set by analog AI3.

4: set by digital pulse quantity X5.

5: through communication settings.

F0 - 18 upper limit frequency	Upper limit frequency ~ maximum frequency [50.00 Hz]
-------------------------------	--

F0 - 19 upper frequency offset	Upper limit frequency ~ maximum frequency [50.00 Hz]
--------------------------------	--

When the upper limit frequency source is set to analog quantity or pulse setting, F0 - 19 is used as the offset amount of the set value, and the offset frequency is superposed with the upper limit frequency value set by F0 - 17 as the set value of the final upper limit frequency.

F0 - 20 lower limit frequency	0.00 Hz ~ upper limit frequency [0.00 Hz]
F0 - 21 operating formula for setting frequency lower	0~2 [0]

When the frequency command is lower than the lower limit frequency set by F0 - 20, the frequency inverter can be stopped, run at the lower limit frequency, or run at zero speed. Which operating mode can be set by F0 - 21 (operating mode with the set frequency lower than the lower limit frequency).

F0 - 22 carrier frequency	0.5 kHz ~ 16 kHz [model determination]
---------------------------	--

This function adjusts the carrier frequency of the frequency inverter. By adjusting the carrier frequency, the noise of the motor can be reduced, the resonance point of the mechanical system can be avoided, the line current to the floor drain can be reduced, and the interference generated by the frequency inverter can be reduced.

When the carrier frequency is low, the higher harmonic component of the output current increases and the motor loss increases, and the temperature rise of the motor increases.

When the carrier frequency is high, the motor loss decreases and the temperature rise of the motor decreases, but the frequency inverter loss increases and the frequency inverter temperature increases.

The rise increases and the interference increases. Adjusting the carrier frequency will affect the following performance:

Carrier frequency	Low → high
Motor noise	Big → small
Output current waveform	Poor → good
Motor temperature rise	High → low
Temperature rise of frequency	Low → high
Leakage current	Small → big
External radiation interference	Small → big

The factory setting of carrier frequency is different for frequency inverters with different power. Although users can modify it according to their needs, and they need to pay attention: if the carrier frequency setting is higher than the factory value, and the temperature rise of the frequency inverter radiator will increase. At this time, users need to use the frequency inverter by derating; otherwise the frequency inverter is in danger of overheating alarm.

F0 - 23 carrier frequencies adjusts with load size	0~1 [1]
--	---------

The carrier frequency is adjusted with the load, which means that when the frequency inverter detects that the load exceeds the rated level, and it will automatically reduce the carrier frequency so as to reduce the temperature rise of the frequency inverter.

When the load decreases to a certain extent, the carrier frequency gradually returns to the set value. This function can reduce the chance of over-heating alarm of frequency inverter.

F0 - 24 LED shutdown operation display selection	0~1 [0]
--	---------

0: shutdown operation display is separated.

During operation, the LED display content is set by F0 - 37 / F0 - 38.

When shutting down, the LED display content is set by F0 - 39.

1: stop operation display does not separate

During operation, the LED display content is set by F0 - 37 / F0 - 38.

When shutting down, the LED display content is set by F0 - 37 / F0 - 38.

F0 - 26 digital setting frequency shutdown memory selections	0~1 [1]
--	---------

This function is only valid when the frequency source is set digitally.

0: "no memory" means that after the frequency inverter is shut down, the digital set frequency value is restored to F0 - 09 (preset frequency) values, keyboard ▲ and ▼ keys or frequency correction by terminals up and down are cleared.

1: "memory" means that after the frequency inverter is shut down, the digital set frequency will remain the set frequency at the time of the last shutdown. Frequency correction by keys ▲, ▼ or terminals up and down remains valid.

F0 - 27 runtime frequency command up / down reference	0~1 [1]
---	---------

This parameter is valid only if the frequency source is set digitally.

0: the operating frequency is the benchmark.

When the ▲, ▼ keys or terminals up / down of the keyboard are operated, what method is used to correct the set frequency, that is, the target frequency rate is increased or decreased based on the operating frequency.

1: set frequency as reference.

When the ▲, ▼ keys or terminals up / down of the keyboard are operated, what method is used to correct the set frequency, that is, the target frequency the rate is increased or decreased based on the set frequency.

The difference between the two settings is obvious when the frequency inverter is in the process of acceleration and deceleration, that is, if the frequency of operation of the frequency inverter, When the rate is different from the set frequency, the different choices of this parameter are very different.

F0 - 28 motor selection	0~1 [0]
-------------------------	---------

HV610 supports the application of time-sharing drive of two motors by frequency inverters. The two motors can respectively set motor nameplate parameters, independent parameter tuning, select different control modes, and independently set parameters related to operation performance, etc. The user selects the current motor parameter group through the F0 - 28 function code, and who can also switch the motor parameters through the digital quantity input terminal X. When the function code selection conflicts with the terminal selection, the terminal selection shall prevail

0: motor 1.

The corresponding functional parameter groups of motor parameter group 1 are f1 group and F2 group.

1: motor 2

Motor parameter group 2 corresponds to functional parameter group FB.

F0 - 29 auxiliary frequency source y	0~9 [0]
--------------------------------------	---------

When the auxiliary frequency source is given a channel as an independent frequency (i.e. the frequency source is selected as X to Y switch), its usage is the same as that of the main frequency source X. the usage method can refer to the relevant description of F0 - 03.

When the auxiliary frequency source is used for superposition and given (i.e. the composite implementation frequency of the main frequency source X and the auxiliary frequency source Y is given), attention should be paid to:

1. When the auxiliary frequency source is given by numbers, the preset frequency (F0 - 09) does not work, and the user can select the preset frequency (F0 - 09) through the keyboard ▲, ▼ key (or up and down of multi-function input terminal) adjusts the frequency directly on the basis of the main given frequency.

2. When the auxiliary frequency source is given by analog input (AI1, AI2, and AI3) or pulse input, the input setting of 100 % corresponds to the auxiliary frequency source range, which can be set through F0 - 30 and F0 - 31.

3. Frequency source for pulse input timing, similar to analog given. Tips: the selection of the auxiliary frequency source Y and the selection of the main frequency source X cannot be set to the same channel, i.e. F0 - 03 and F0 - 29 should not be set to the same value, otherwise it will easily cause confusion.

F0 – 30 Selection of Y range of auxiliary frequency source during superposition	0~1 [0]
F0 – 31 Auxiliary frequency source Y range when is superimposed	0~150% [0%]

These two parameters are used to determine the adjustment range of the auxiliary frequency source when the frequency source is selected as "frequency superposition".

F0 - 30 is used to determine the object corresponding to the auxiliary frequency source range. It can be selected to be relative to the maximum frequency, or it can be with respect to the main frequency source x, if selected with respect to the main frequency source, the range of the auxiliary frequency source will vary with the change of the main frequency X.

F0 - 32 frequency source superposition selection	0~34 [0]
--	----------

The given channel of frequency is selected through this parameter. The frequency is given by the combination of the main frequency source X and the auxiliary frequency source Y.

Bits: frequency selection. Select the mode of frequency superposition or switching.

0: only the primary frequency X and the secondary frequency Y do not overlap. $F=X$.

1: the superposition mode of frequency is determined by ten bits.

2: the main frequency X and the auxiliary frequency Y are switched through the No. 18 function of the X terminal.

Function terminal No. 18 is closed for auxiliary y, and the terminal is broken on for the main frequency Y

3: main frequency X and main and auxiliary operation results switch. Terminal switching function is No. 18.

4: secondary frequency Y and primary and secondary operation results switch. Terminal switching function code No. 18.

10 bits: frequency primary and secondary operation relation

0: X+Y

1: X-Y

2: min (X, Y), whichever is the maximum in the primary and secondary

3: max (X, Y), minimum value in main and auxiliary

F0 – 33 Offset frequency of auxiliary frequency source when is superimposed	0 ~ maximum frequencies [0.00 Hz]
---	-----------------------------------

When the frequency source is selected as the main and auxiliary operation, the offset frequency can be set through F0 - 33, and the offset frequency can be superimposed on the main and auxiliary operation results to flexibly cope with various requirements.

F0 - 34 command source bundling frequency source	0~999 [000]
--	-------------

Bits: panel command binding frequency source selection

0: no binding

1: digital setting frequency source.

2: AI1

3: AI2

4: AI3

5: pulse quantity X5

6: multi-segment speed

7: simple PLC

8: PID

9: communication given

10 bits: terminal command binding frequency source selection (0 ~ 9, same bit)

100 bits: communication command binding frequency source selection (0 ~ 9, same bit)

Defines the binding combination between three kinds of operation command channels and nine kinds of frequency given channels to facilitate synchronous switching change.

The meaning of the given channel of the above frequency is the same as that of F0 - 03 selected by the main frequency source X. please refers to F0 - 03 function code descriptions. Different run command channels can bind a given channel with the same frequency.

When the command source has a bundled frequency source, other set frequency sources will no longer function during the period when the command source is active.

F0 - 35 cooling fan control	0~1 [0]
-----------------------------	---------

0: fan running when running;

The frequency inverter operates the fan in the running state, the fan rotates when the radiator temperature is higher than 40 degrees in the shutdown state, and the fan does not operate when the radiator temperature is lower than 40 degrees in the shutdown state.

1: the fan has been running all the time;

The fan has been running since it was powered on.

F0 - 36 forward and reverse dead time	0.0s~3000.0s [0.0s]
---------------------------------------	---------------------

Set the transition time at the output of 0 Hz during the forward and reverse transition of the frequency inverter, as shown in figure 5 - 02:

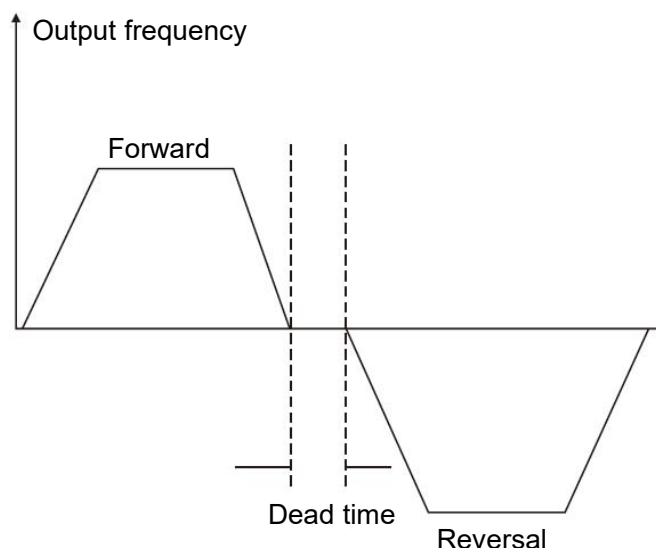

Figure 5 - 02 schematic diagram of dead time for forward and reverse rotation

F0 - 37 Parameter 1 displayed at run time	0000~FFFF [H401F]
---	-------------------

F0 - 38 Parameter 2 displayed at run time	0000~FFFF [H401F]
---	-------------------

F0 - 39 Parameter 1 displayed at stop	0000~FFFF [H401F]
---------------------------------------	-------------------

Please refer to the instructions in appendix 2.

F0 - 40 load speed display factor	0.0001~6.5000 [3.0000]
-----------------------------------	------------------------

When it is necessary to display the load speed, the corresponding relation between the output frequency of the frequency inverter and the load speed is adjusted through this parameter. Please refer to F0 - 41 for specific correspondence.

F0 - 41 load speeds displays decimal places	0~32 [21]
---	-----------

Bit:

Used to set the number of decimal places for load speed display. The following example illustrates how to calculate the load speed:

If the load speed (u0 - 14) shows a coefficient F0 - 40 of 2.000 and the number of decimal places F0 - 40 of the load speed is 2 (2 decimal places), when the frequency inverter is running at 40.00 Hz, the load speed is $40.00 * 2.000 = 80.00$ (2 decimal point display)

If the frequency inverter is stopped, the load speed is displayed as the speed corresponding to the set frequency, i.e. "set load speed ". Taking the set frequency of 50.00 Hz as an example, the load speed in shutdown state is $50.00 * 2.000 = 100.00$ (2 decimal point display)

10 bits:

1: U0 - 19 / U0 - 29 are displayed with 1 decimal point respectively.

2: U0 - 19 / U0 - 29 are displayed with 2 decimal point respectively.

F0 - 42 GP type display	1 ~ 2 [model determination]
-------------------------	-----------------------------

This parameter is only for users to view the factory model and cannot be changed.

Model 1: G (constant torque load model), suitable for constant torque load with specified rated parameters

Type 2: P (Fan pump type load model), suitable for variable torque load with specified rated parameters (Fan pump load)

Note: F0 - 42 is only for display and cannot be modified. The selection of G/P machine is set in function code F8 - 02

F0 - 43 personality parameter mode display selection	0~11 [00]
--	-----------

Bit: user specified parameter display selection 0: not displayed

1: display ten digits: user changes parameter display selection 0: not displayed

1: Display

The setting up of the parameter display mode is mainly to facilitate users to view the functional parameters of different arrangement modes according to actual needs, and to provide three parameter display modes.

Name	Description
Function parameter mode	The functional parameters of the frequency inverter are displayed in sequence, including F0 ~ FP, P0 ~ P3, U0~UF functional parameter groups
User - customized parameter method	The user customizes the individual function parameters displayed (up to 32). The user determines the function parameters to be displayed through the Fe group.
Method for user to change parameters	Functional parameters inconsistent with factory parameters

When there is a display for personality parameter mode display selection (F0 - 43), you can switch to different parameter display modes through quick key at this time. The default value is only function parameter mode display.

F0 - 44 function code modification attribute	0~1 [0]
--	---------

0: modifiable, user can modify function code through panel keyboard or communication.

1: cannot be modified. All function codes can only be viewed and cannot be modified.

F0 - 45 keyboard knob sensitivity	0~3 [2]
-----------------------------------	---------

The greater the F0 - 45 setting, the more sensitive the keyboard shuttle (or up down operation) is, the smaller the setting, and the less sensitive it is.

Note: this function is only valid for up and down addition and subtraction of level 0 menus, and other functions are invalid.

F0 - 46 user password	0~65535 [0]
-----------------------	-------------

F0 - 46 sets any non-zero number, the password protection function takes effect. The next time you enter the menu, you must enter the password correctly, and otherwise you cannot view and modify the function parameters. Please keep in mind the user password you have set. If F0 - 46 is set to 00000, then the set user password will be cleared and the password protection function will be invalid.

F0 - 47 initialization	0~65535 [0]
------------------------	-------------

0: no operation.

1001: restore factory settings, excluding motor parameters

After setting F0 - 47 as 1001, most of the frequency inverter function parameters are restored to factory parameters, but motor parameters, frequency command decimal point, fault record information, accumulated running time, accumulated power-on time, and accumulated power consumption are not restored.

1002: clear record information

Clear frequency inverter fault record information, accumulated running time, accumulated power-on time, and accumulated power consumption.

F1 Group first motor parameters

F1 - 01 rated power	0.1 kW ~ 1000.0 kW [model determination]
F1- 02 rated voltage	1V ~ 2000 V [model determination]
F1- 03 rated current	0.01A~655.35A (frequency inverter power <= 55Kw)
F1 - 04 rated frequency	0.01 Hz ~ maximum frequency [model determination]
F1 - 05 rated rotational speed	1 rpm ~ 65535 rpm [model determination]

Set the parameters of the controlled motor

In order to ensure the control function, be sure to set F1-01~F1-05 correctly according to the nameplate parameters of the motor.

In order to obtain better VF or vector control performance, motor parameters need to be tuned, and the accuracy of the adjustment results is closely related to the correct setting of motor nameplate parameters.

F1-06 stator resistance of asynchronous motor	0.001Ω~65.535Ω(frequency inverter power ≤55kW) 0.0001 ~ 6.5535 (frequency inverter power > 55kW) [model determination]
F1-07 rotor resistance of asynchronous motor	0.001Ω~65.535Ω(frequency inverter power ≤55kW) 0.0001 ~ 6.5535 (frequency inverter power > 55kW) [model determination]
F1-08 induction motor leakage reactance	0.01 ~ 655.35 mH (frequency inverter power ≤ 55 kW) 0.001 ~ 65.535 mH (frequency inverter power > 55 kW) [model determination]
F1-09 mutual inductance reactance of asynchronous motor	0.1 ~ 6553.5 mH (frequency inverter power ≤ 55 kW) 0.01 ~ 655.35 mH (frequency inverter power > 55 kW) [model determination]
F1-10 asynchronous motor no-load current	0.01A ~ F1 - 03 (frequency inverter power ≤ 55kW) 0.1A ~ F1 - 03 (frequency inverter power > 55kW) [model determination]

F1-06~F1-10 is parameters of asynchronous motors. These parameters are generally not found on the motor nameplate and need to be automatically tuned by the frequency inverter. Among them, "asynchronous motor static tuning" can only obtain F1-06~F1-08 three parameters, while " asynchronous motor complete tuning" can obtain not only all five parameters here, but also encoder phase sequence, current loop PI parameters, etc.

When changing the rated power of the motor (F1 - 01) or the rated voltage of the motor (F1 - 02), the frequency inverter will automatically modify the F1 - 06 ~ F1 - 10 parameter values to restore these 5 parameters to the common standard Y series motor parameters. If it is impossible to tune the asynchronous motor on site, you can enter the above-mentioned corresponding function code according to the parameters provided by the motor manufacturer.

F0 - 29 motor parameters self - tuning	0~3 [0]
--	---------

0: no operation.

1: simple static self - tuning.

It is suitable for asynchronous motors where large inertia loads are not easy to disengage and cannot be rotated.

2: rotational self - tuning

During the complete setting process, the frequency inverter will first perform static setting, and then accelerate to 80 % of the rated frequency of the motor according to the acceleration time F0 - 10. After maintaining for a period of time, the frequency inverter will slow down and shut down according to the deceleration time F0 - 11 and end the setting.

3. Advanced static self-tuning

Is applicable to the case where there is no encoder, and the motor parameters are self-learned when the motor is at rest (at this time, the motor may still have slight shaking)

Description:

1. Tuning supports motor tuning in keyboard operation mode, terminal mode and communication mode.

2. In order to ensure the optimal control performance of the frequency inverter during vector control, please disconnect the load from the motor and use rotational tuning to self-learn the motor parameters; otherwise it will affect the vector control effect. Please use static tuning 2 when the motor has a large inertia load which is not easy to disengage and vector control is required.

3. Steps

3.1 Motor type and nameplate parameters F1-00~F1-05 must be set correctly.

3.2 F1 - 29 = 1 or 2 or 3. The panel displays the word STUDY at this time.

3.3 Then press the run key, and the frequency inverter will be set.

3.4 When the operation light on the panel goes out, it indicates that the setting is done.

F2 Group motor vector control parameters

F2 group function codes are only valid for vector control and invalid for VF control.

F2 - 00 speed loop proportional gain kp1	1~100 [30]
F2 - 01 speed loop proportional gain Ti1	0.01~10.00 [0.50s]
F2 - 02 switching frequency f1	0.00~F2-05 [5.00hz]
F2 - 03 speed loop proportional gain kp2	1~100 [20]
F2 - 04 speed loop proportional gain Ti2	0.01~10.00 [1.00s]
F2 - 05 switching frequency F2	F2 - 05 ~ maximum frequency [10.00 Hz]

The frequency inverter operates at different frequencies, and different PI parameters of the speed loop can be selected.

When the operating frequency is less than the switching frequency 1 (F2 - 02), the speed loop pi adjustment parameters are F2 - 00 and F2 - 01.

When the operating frequency is greater than the switching frequency 2, the speed loop pi adjustment parameters are F2 - 03 and F2 - 04.

The speed loop pi parameters between switching frequency 1 and switching frequency 2 are linearly switched by two sets of pi parameters, as shown in figure 5 - 03:

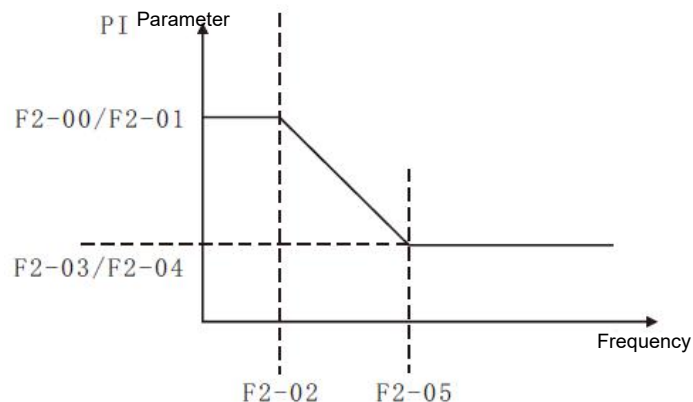

Figure 5 - 03 pi parameter diagram

By setting the proportional coefficient and the integration time of the speed regulator, the speed dynamic response characteristics of the vector control can be adjusted.

Increasing the proportional gain and decreasing the integration time can accelerate the dynamic response of the speed loop. However, too much proportional gain or too little integration time may cause the system to oscillate.

The suggested adjustment method is:

If the factory parameters cannot meet the requirements, fine-tune them based on the factory value parameters to increase the proportion and benefit first, so as to ensure that the system does not oscillate. Then reduce the integration time so that the system has faster response characteristics and less overshoot.

For vector control without speed sensor, this parameter is used to adjust the speed stability accuracy of the motor: when the motor is loaded with low speed, this parameter is increased, and vice versa.

Note: improper setting of pi parameters may lead to excessive speed overshoot. Even when overshoot falls back, over-voltage faults occur.

F2-06 vector controlled slip gain	50%~200% [100%]
F2-07 SVC torque filter time constant	0.000s~0.100s [0.000s]
F2-09 torque upper limit source under speed control mode	0~5 [0]
F2-10 torque upper limit digital setting under speed control mode	0.0%~200.0% [150.0%]

In the speed control mode, the maximum output torque of the frequency inverter is controlled by the torque upper limit source.

0: set by F2 - 10 digits.

1: AI1 analog setting.

2: AI2 analog setting.

3: AI3 analog setting.

4: XI pulse setting.

5: Communication settings.

Description:

F2 - 09 is used to select the setting source of the upper torque limit. When setting through analog quantity, PULSE pulse and communication, 100 % of the corresponding setting corresponds to F2 - 10, while 100 % of F2 - 10 is the rated torque of the frequency inverter. For AI1, AI2, AI3, X5 settings, please refer to the introduction of F4 AI curve.

When the selection is communication setting

The host computer writes -100.00% ~ 100.00% of the data through the communication address 0x1000, of which 100.00 % corresponds to F2 - 10.

F3 Group V/F control parameters

This group of function codes is only valid for V/F control and invalid for vector control.

F3 - 00 V/F curve setting	0~11 [0]
---------------------------	----------

0: straight line V/F.

Suitable for common constant torque load.

1: multipoint V/F.

Suitable for special loads such as dehydrators and centrifuges at this time, by setting F3 - 03 to F3 - 08 parameters, any desired VF relation curve can be obtained.

2: square V/F. Suitable for centrifugal loads such as fans and water pumps.

3 ~ 8: VF relation curve between straight line VF and square VF.

10: VF complete separation mode.

At this time, the output frequency of the frequency inverter and the output voltage are independent of each other. The output frequency is determined by the frequency source, while the output voltage is determined by F3 - 13 (VF separated voltage source).

VF complete separation mode is generally used in induction heating, frequency inverter power supply, torque motor control and other occasions.

11: VF semi-detached mode.

V and F are proportional in this case, but the proportional relationship can be set by the voltage source F3 - 13, and V and F are the relationship is also related to the rated voltage and frequency of F1 group motors.

Assuming that the voltage source input is X (X is a value of 0 - 100 %), the relationship between the frequency inverter output voltage v and frequency f is: $V/F = 2 * X * (\text{rated voltage of motor}) / (\text{rated frequency of motor})$

F3 - 01 torque boost	0.0 % ~ 30 % [model determination]
F3 - 02 torque boost cutoff frequency	0.00 Hz ~ maximum output frequency [50.00 Hz]

In order to compensate for the V/F control low frequency torque characteristics, the frequency inverter output voltage is compensated for some lift at low frequency. However, the setting of torque increase is too large, the motor is easy to overheat, and the frequency inverter is easy to over current.

This parameter is recommended to be increased when the load is heavy and the starting torque of the motor is insufficient. The torque lift can be reduced when the load is light.

When the torque increase is set to 0.0, the frequency inverter will automatically increase the torque. At this time, the frequency inverter will automatically calculate the required torque increase value based on the motor stator electrical resistance and other parameters.

Torque boost torque cutoff frequency: under this frequency, the torque boost torque is valid. If it exceeds this set frequency, the torque boost will fail. See figure 5 - 04 for details.

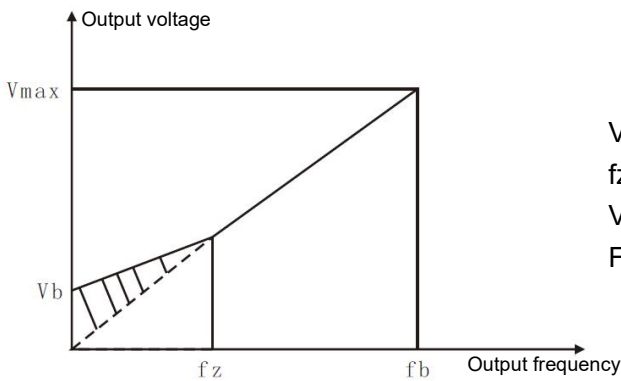

Vb: manual torque lifting diagram (lifting amount is shaded part)
 fz: cut-off frequency of torque lifting
 Vmax: maximum output voltage
 FB: basic operating frequency

Figure 5 - 04 schematic diagram of manual torque boost
 (The lifting amount is the shaded part)

F3 - 03 V/F frequency value f1	0.00Hz ~ F3-05 [0.00Hz]
F3 - 04 V/F voltage v1	0.0% ~ 100.0% [0.0]
F3 - 05 V/F frequency value F2	F3-03 ~ F3-07 [0.00Hz]
F3 - 07 V/F frequency value F3	F3 - 05 ~ rated frequency of motor (f1 - 04) [0.00Hz]
F3 - 08 V/F voltage v3	0.0% ~ 100.0% [0.0]

1. The curve of multi-point V/F shall be set according to the load characteristics of the motor. When setting, it is necessary to confirm that the following conditions are established: $v1 < v2 < v3$, $f1 < F2 < F3$.

2. Figure 5 - 05 is a schematic diagram of setting multi-point VF curve.

Too high voltage setting at low frequencies may cause the motor to overheat or even burn down, and the frequency inverter may be over-run or over-current protected.

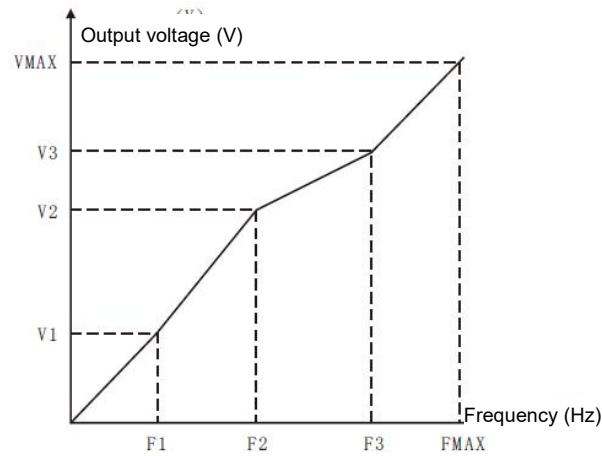

Figure 5 - 05 multi-point V/F curve setting diagram

F3 - 09 VF slip compensation gain	0%~200.0% [0.0%]
-----------------------------------	------------------

VF slip compensation can compensate the motor speed deviation of asynchronous motor when the load increases, so that the motor speed can basically remain stable when the load changes.

VF slip compensation gain is set to 100.0 %, which indicates that the compensated slip is the rated slip of the motor when the motor is under rated load.

When adjusting VF slip compensation gain, it is generally based on the principle that the motor speed is basically the same as the target speed under the rated load. When the motor speed is different from the target value, it is necessary to adjust the gain appropriately.

F3 - 10 VF over-excitation gain	0~200 [64]
---------------------------------	------------

In the process of frequency inverter deceleration, over-excitation control can suppress the rise of bus voltage and avoid over-voltage fault. The greater the over-excitation gain, the stronger the suppression effect.

When the frequency inverter is prone to over-voltage alarm during deceleration, it is necessary to increase the over-excitation gain. However, the over-excitation gain is too large, which easily leads to an increase in the output current and needs to be weighed in the application.

When the inertia is very small, no voltage rise will occur during motor deceleration, it is recommended to set the over-excitation gain to 0. It is also recommended to set the over-excitation gain to 0 when there is a braking resistance.

F3 - 11 VF oscillation suppression gain	0 ~ 100 [model determination]
---	-------------------------------

The gain is chosen to be as small as possible on the premise of validly suppressing oscillation so as not to adversely affect VF operation. Please select the gain of 0 when the motor does not oscillate. Only when the motor is obviously oscillating can the gain be appropriately increased. The greater the gain, the more obvious the suppression of oscillation is.

When using the function of suppressing oscillation, it is required that the rated current and no-load current parameters of the motor are accurate, otherwise VF oscillation suppression effect is not good.

F3 - 13 VF separated voltage source	0~8 [0]
F3 - 14 VF separated voltage digital setting	0~Rated voltage of motor [0]

VF separation is generally used in induction heating, frequency inverter power supply, torque motor control and other occasions.

When VF separation control is selected, the output voltage can be set through function code F3 - 14, or it can come from analog quantity, multi - Segments instruction, PLC, PID or communication given. When non-digital setting is used, each set 100 % corresponds to the rated voltage of the motor, and when the percentage set by the analog output is negative, the set absolute value is taken as the valid setting value.

0: the digital setting (F3 - 14)

Voltage is set directly by F3 - 14.

1: AI1

2: AI2

3: AI3

The voltage is determined by the analog input terminal.

4. Pulse pulse setting (XI5)

Voltage is given by terminal pulse.

Pulse given signal specification: voltage range 9V~30V, frequency range 0kHz~100kHz.

5. Multiple instructions

When the voltage source is a multi-segment instruction, F5 group and FC group parameters should be set to determine the correspondence between a given signal and a given voltage. The FC group parameter multi-segment command gives 100.0 %, which is the percentage relative to the rated voltage of the motor.

6. When the simple PLC

Voltage source is a simple PLC, FC group parameters need to be set to determine the given output voltage.

7. PID

The output voltage is generated according to the PID closed loop. Please refer to FA group PID for details.

8. Communication given

The voltage is given by the upper computer through communication.

VF separation voltage source selection is similar to frequency source selection; see F0 - 03 main frequency source selection introductions. Of which, 100.0 % of the corresponding setting for each type of selection refers to the rated voltage of the motor (taking the absolute value of the corresponding setting value)

F3 - 15 VF separation voltage acceleration time	0.0S~1000.0S 【0.0S】
F3 - 16 VF separation voltage deceleration time	0.0S~1000.0S 【0.0S】

The voltage acceleration time for VF separation refers to the time required for the output voltage to accelerate from 0 to the rated voltage of the motor, as shown in T1 in figure 5 - 06.

The voltage deceleration time for VF separation refers to the time required for the output voltage to decelerate from the rated voltage of the motor to 0, as shown in figure 5 - 06.

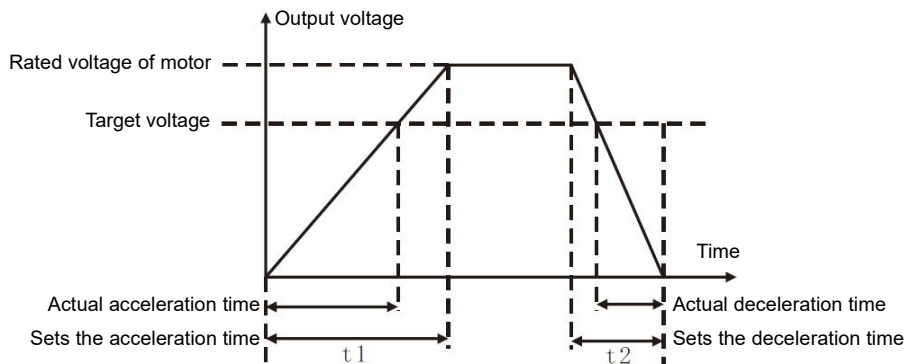

Figure 5 - 06 V/F separation diagram

F3 - 17 VF Shutdown mode for separations	0~1 [0]
--	---------

0: frequency and voltage independently reduced to 0.

1: the voltage is reduced to zero before the frequency is reduced.

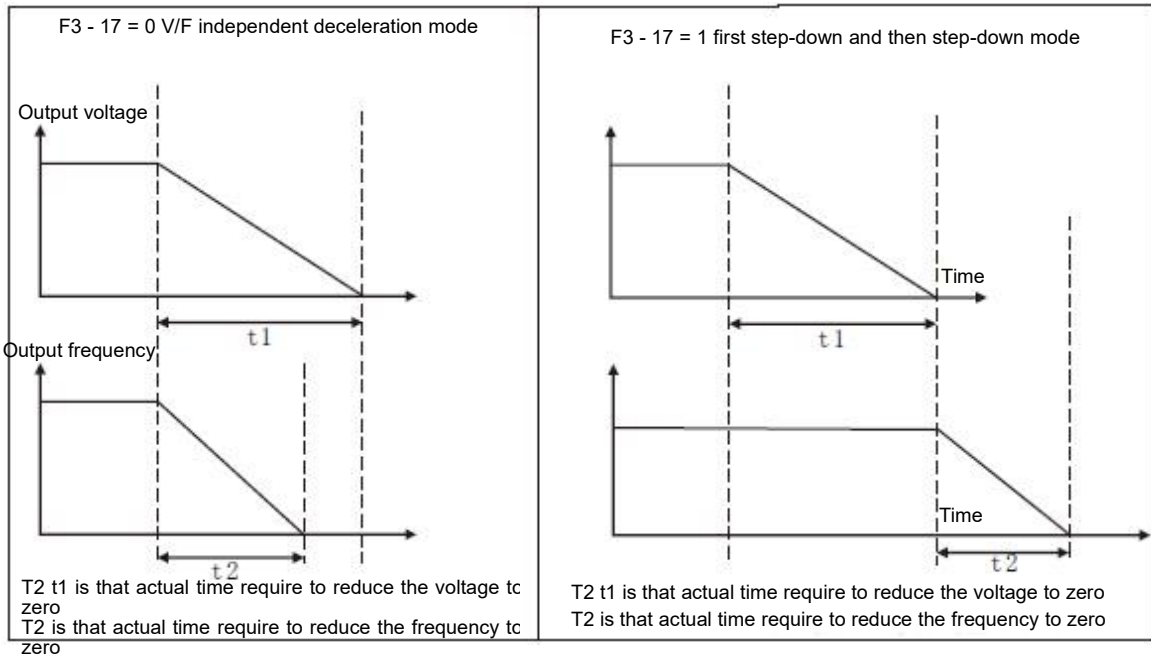

Figure 5 - 07 V/F separation shutdown process diagram

F4 Group output terminals

F4 - 00 FM terminal output mode selection	0~1 [0]
---	---------

The FM terminal is a programmable multiplex terminal, which can be used as a high-speed pulse output terminal (FMP) or as a switch output terminal (FMR) with open collector.

0: high-speed pulse output terminal.

When outputting FMP as pulse, the highest frequency of the output pulse is 100 kHz. See F4 - 06 for FMP related functions instruction.

1: Open collector output terminal.

When switching output is used, the output function is set by F4 - 01 function code.

F4-01 FMR Open collector output terminal	0~42 [0]
F4-02 relay output function selection (T/A-T/B-T/C)	0~42 [2]
F4-04 DO1 open collector output terminal	0~42 [0]

The function of the multi-function output terminal is explained as follows:

Setting value	Functionalities	Description
0	No output	The output terminal has no function
1	The frequency inverter is in operation	Indicates that the frequency inverter is running and has an output frequency (which can be zero). At this time, the on signal is output.

Setting value	Functionalities	Description
2	Fault output (fault shutdown)	When the frequency inverter fails and the fault stops, an on signal is output.
3	Frequency level detection FDT1 output	Please refer to the descriptions of function codes F4 - 24 and F4 - 25.
4	Frequency arrival	Please refer to the description of function code F4 - 28.
5	Zero speed operation (no output during shutdown)	When the frequency inverter is running and the output frequency is 0, the on signal is output. This signal is OFF when the frequency inverter is in shutdown state.
6	Motor overload pre - alarm	Before the motor overload protection action, judge according to the threshold of overload pre - alarm, and output an on signal after exceeding the pre-alarm threshold. Refer to function code F9 - 00 ~ F9 - 02 for motor overload parameter setting.
7	frequency inverter overload pre - alarm	Output on signal 10s before frequency inverter overload protection occurs.
8	Set the count value to reach	When the count value reaches the value set by F8 - 31, an on signal is output.
9	Specified count value arrives	When the count value reaches the value set by F8 - 32, an on signal is output. Refer to FB group function description for counting function
10	Length arrival	When the detected actual length exceeds the length set by F8 - 28, an on signal is output.
11	PLC cycle completed	When the simple PLC runs through a cycle, a pulse signal with a width of 250ms is output.
12	Accumulated operating time arrives	When the accumulated running time of the frequency inverter exceeds the time set by F8 - 01, an ON signal is output.
13	Frequency limit	When the set frequency exceeds the upper limit frequency or the lower limit frequency and the output frequency of the frequency changer also reaches the upper limit frequency or the lower limit frequency, an ON signal is output.
14	Torque limitation	In the speed control mode, when the output torque reaches the torque limit, the frequency inverter is in stall protection state and outputs an ON signal at the same time.
15	Operational readiness	When the power supply of the main circuit and the control circuit of the frequency inverter has stabilized and the frequency inverter has not detected any fault information, and the frequency inverter is in an operable state, an ON signal is output.
16	AI1>AI2	When the value of analog input AI1 is greater than the input value of AI2, an ON signal is input.
17	Upper frequency arrival	When the operating frequency reaches the upper limit frequency, an ON signal is input.
18	Lower limit frequency reached (not input during shutdown)	When the operating frequency reaches the lower limit frequency, an ON signal is input. This signal is OFF when the machine is stopped.
19	Under voltage state output	When the frequency inverter is in the under voltage state, an ON signal is input.
20	Communication settings	Please refer to the communication protocol.

Setting value	Functionalities	Description
21	Reserve	Reserve
22	Reserve	Reserve
23	Zero speed operation in 2 (also input during shutdown)	When the output frequency of the frequency inverter is 0, the on signal is output. This signal is also in shutdown state.
24	Cumulative power-on time arrives	When the frequency inverter's accumulated power-on time (U0 - 71) exceeds the time set by F8 - 00, the frequency inverter outputs an on signal.
25	Frequency level detection FD T2 output	Please refer to the descriptions of function codes F4 - 26 and F4 - 27.
26	Frequency 1 reaches output	Please refer to the descriptions of function codes F4 - 29 and F4 - 30.
27	Frequency 2 reaches output	Please refer to the descriptions of function codes F4 - 31 and F4 - 32.
28	Current 1 reaches output	Please refer to the descriptions of function codes F4 - 33 and F4 - 34.
29	Current 2 reaches output	Please refer to the descriptions of function codes F4 - 35 and F4 - 36.
30	Timed arrival output	When the timing function selection (F8 - 04) is valid, the on signal will be output after the current running time of the frequency inverter reaches the set timing time.
31	Ai1 input overrun	When the value of analog input AI1 is greater than F4 - 37 (AI1 input protection upper limit) or less than F4 - 38 (AI1 input protection lower limit), the signal is input.
32	Off loading	When the frequency inverter is in the off-load state, an ON signal is output.
33	In reverse operation	When the frequency inverter is in reverse operation, an ON signal is output.
34	Zero current state	Please refer to the descriptions of function codes F4 - 33 and F4 - 34
35	Module temperature reached	When the frequency inverter module radiator temperature (U0 - 69) reaches the set module temperature reaching value (F4 - 39), an ON signal is output
36	Software current overrun	Please refer to the descriptions of function codes F4 - 42 and F4 - 43.
37	Lower limit frequency reached (shutdown also output)	When the operating frequency reaches the lower limit frequency, an ON signal is output. This signal is also ON during shutdown.
38	Alarm output	When the frequency inverter fails and the processing mode of the failure is continuous operation, the frequency inverter gives an alarm output.
39	The running time has arrived	When the starting operation time of the frequency inverter exceeds the time set by F8 - 07, the on signal is output.
40	Fault output	Under voltage does not output.
41	AI1 is lower than lower limit output	When the value of AI1 is lower than F4 - 37, output
42	AI1 above upper limit output	When AI1 value is higher than F4 - 38, output
43	AI2 output below lower limit	When AI2 value is lower than F4 - 37, output
44	AI2 above upper limit output	When AI2 value is higher than F4 - 38, output

F4-06 FMP output function selection (pulse output terminal)	0~16 [0]
F4-07 AO1 output function selection	0~16 [0]
F4-08 AO2 output function selection	0~16 [1]

The FMP terminal output pulse frequency ranges from 0.01 kHz to F4 - 09 (FMP output the maximum frequency), and F4 - 09 can be set between 0.01 kHz and 100.00 kHz.

The analog outputs AO1 and AO2 range from 0V to 10V, or 0 mA to 20 mA.

The calibration relationship between the range of pulse output or analog output and corresponding functions is shown in the following table:

Setting value	Functionalities	Description
0	Running frequency	0 ~ maximum output frequency
1	Set frequency	0 ~ maximum output frequency
2	Output current	0 ~ 2 times rated current of motor
3	Output torque (absolute value)	0 ~ 2 times rated torque of motor
4	Output power	0 ~ 2 times rated power
5	Output voltage	0 ~ 1.2 times rated voltage of frequency inverter
6	PULSE pulse input	0.01kHz~100.00kHz
7	AI1	0V~10V
8	AI2	0V~10V (or 0~20mA)
9	AI3	0V~10V
10	Length	0 ~ maximum set length
11	count value	0 ~ maximum count value
12	Communication settings	0.0% - 100.0%
13	Motor rotational speed	Rotational speed corresponding to 0 ~ maximum output frequency
14	Output current	0.0A~1000.0A
15	Output voltage	When 0.0v to 1000.0v
16	Output torque (actual value)	- 2x motor rated torque ~ 2x motor rated torque

F4 - 09 FMP output maximum frequency	0.01kHz~100.00kHz [50.00Khz]
F4 - 10 AO1 zero offset coefficient	-100.0%~+100.0% [0.0%]
F4 - 11 AO1 gain	-10.00~+10.00 [1.00]
F4 - 12 AO2 zero offset coefficient	-100.0%~+100.0% [0.0%]
F4 - 13 AO2 gain	-10.00~+10.00 [1.00]

The above function codes are generally used to correct the zero offset of the analog output and the deviation of the output amplitude. It can also be used to customize the required AO output curve.

If the zero offset is represented by "b", the gain is represented by k, the actual output is represented by y, and the standard output is represented by x, the actual output is: $Y = kX + b * 10V$.

Among them, the zero offset coefficient of AO1 and AO2 is 100 % corresponding to 10v (or 20mA), and the standard output refers to the output of 0V - 10V (or 0mA - 20mA) corresponding to the amount indicated by the analog output without zero offset and gain correction.

For example, if the analog output content is operating frequency, it is expected to output 8v at frequency 0 and 3v at maximum frequency, then the gain should be set to " - 0.50" and the zero offset should be set to " 80 %".

F4-17 FMR output delay time	0.0s~3600.0s [0.0S]
F4-18 relay1 output delay time	0.0s~3600.0s [0.0S]
F4-20 DO1 output delay time	0.0s~3600.0s [0.0S]

Set the output terminals FMR, relays 1, DO1 to delay the change from the state to the actual output.

F4 - 22 selection of valid state of output terminal	00000~11111 [00000]
---	---------------------

BIT0:FMR positive and negative logic definition
 BIT1: relay 1 positive and negative logic definition
 BIT3: DO1 positive and negative logic definition

Figure 5 - 08

Defines the output logic of the output terminals FMR, relay 1, DO1. 0: positive logic, the digital quantity output terminal and the corresponding common terminal are connected in a valid state and disconnected in an invalid state;

1: reverse logic, the connection between the digital quantity output terminal and the corresponding common terminal is invalid, and the disconnection is valid.

F4-24 frequency detection value (FD t1)	0.00 Hz ~ maximum frequency [50.00 Hz]
F4-25 frequency detection lag value (FD t1)	0.0 % ~ 100.0 % (FD t1 level) [5.0 %]
F4-26 frequency detection value (FD T2)	0.00 Hz ~ maximum frequency [50.00 hz]
F4-27 frequency detection lag value (FD T2)	0.0 % ~ 100.0 % (FDT2 level) [5.0 %]

When the operating frequency is higher than the frequency detection value, the multi-function output (No. 03 FDT1, No. 25 FDT2) DO of the frequency inverter outputs on signal, while when the frequency is lower than the detection value by a certain frequency value, the DO output on signal is cancelled.

The above parameters are used to set the detection value of the output frequency and the hysteresis value of the release of the output action. Wherein F4 - 25 / F4 - 27 is the percentage of lag frequency relative to the frequency detection value F4 - 24 / F4 - 26. Figs. 5 - 09 show the intent of the FDT function.

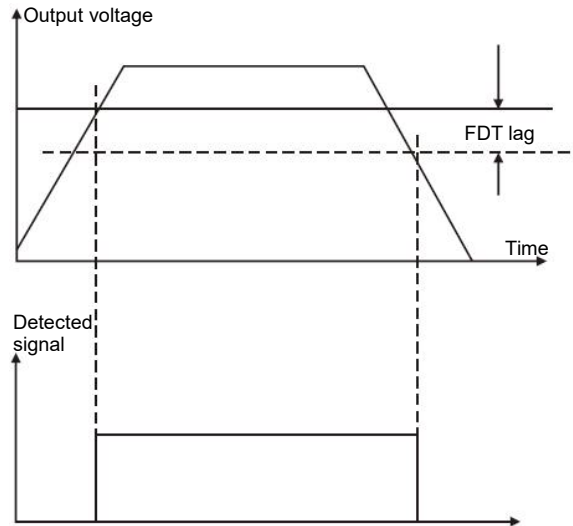

Figure 5 - 09 FDT level diagram

F4 - 28 frequencies reaches detection width	0.00 ~ 100 % (maximum frequency) [0.0 %]
---	--

When the operating frequency of the frequency inverter is within a certain range of the target frequency, the multi-function (04) DO of the frequency inverter outputs an on signal.

This parameter is used to set the detection range of frequency arrival and this parameter is a percentage of the maximum frequency. Figure 5 - 10 is a schematic diagram of frequency arrival.

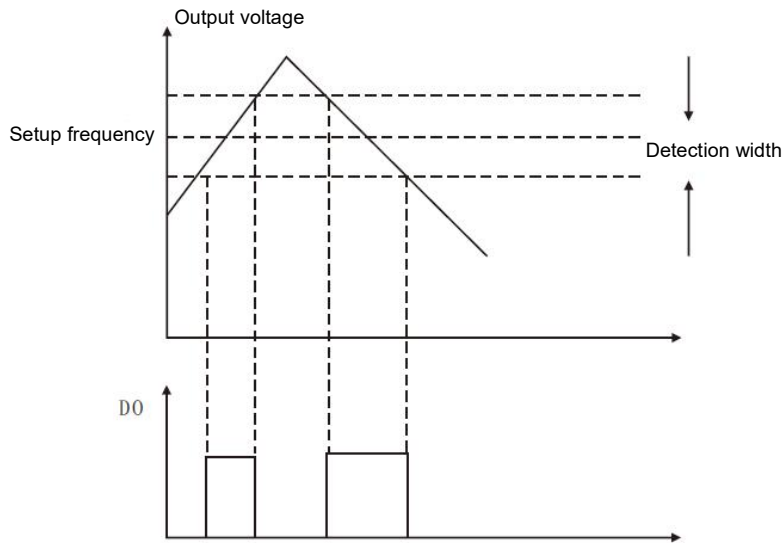

Figure 5 - 10 schematic diagram of frequency arrival detection amplitude

F4-29 random arrival frequency detection value 1	0.00 Hz ~ maximum frequency [50.00 Hz]
F4-30 random arrival frequency detection width 1	0.0%~100.0% [0.0%]
F4-31 random arrival frequency detection value 2	0.00 Hz ~ maximum frequency [50.00 Hz]
F4-32 random arrival frequency detection width 2	0.0%~100.0% [0.0%]

When the output frequency of the frequency inverter is within the positive and negative detection range of any frequency detection value, the multi-function DO (No. 26 and No. 27) outputs on signal

HV610 provides two groups of random arrival frequency detection parameters, setting frequency values and frequency detection ranges respectively. Figure 5 - 11 is a schematic diagram of this function.

F4-33 arbitrarily reaching current 1	0.0 % ~ 300.0 % (rated current of motor) [100.0 %]
F4-34 the width of current 1 is arbitrarily reach	0.0 % ~ 300.0 % (rated current of motor) [0.0%]
F4-35 arbitrarily reaching current 2	0.0 % ~ 300.0 % (rated current of motor) [100.0%]
F4-36 the width of current 2 is arbitrarily reach	0.0 % ~ 300.0 % (rated current of motor) [0.0%]

When the output current of the frequency inverter is set within the positive and negative detection width of any arriving current, the multi-function DO (No. 28 and No. 29) of the frequency inverter outputs on signal.

HV610 provides two groups of random arrival currents and detection width parameters. The detection principle is similar to F4 - 29 ~ F4 - 32.

F4 - 37 AI1 input voltage protection value lower	0.00V~F4-38 [3.1V]
F4 - 38 upper limit of AI1 input voltage	F4-37~10.00V [6.8V]

When the analog input value of AI1 is greater than F4 - 38, or AI1 input value is less than F4 - 37, the multi-function DO (31) of the frequency changer outputs an "AI1 input overrun" ON signal to indicate whether the input voltage of AI1 is within the set range.

F4 - 39 module temperatures reached	0 ~ 100 [75°C]
-------------------------------------	----------------

When the frequency inverter radiator temperature reaches the temperature, the multi-function DO of the frequency inverter outputs the "module temperature reaches" ON message

F4 - 40 zero current detection level	0.0 % ~ 300.0 % (rated current of motor) [5.0%]
F4 - 41 zero current detection delay time	0.00s~600.00s [0.10s]

When the output current of the frequency inverter is less than or equal to the zero current detection level and the duration exceeds the zero current detection delay time, the frequency inverter multifunction (No. 34) DO outputs ON signal.

F4 - 42 output current overrun value	0.0 % (no detection); 0.1% ~ 300.0 % (rated current of motor) [200.0%]
F4 - 43 output current overrun detection delay	0.00s~600.00s [0.00s]

When the output current of the frequency inverter is greater than or exceeds the limit detection point and the duration exceeds the software over current point detection delay, the frequency inverter multifunction (No. 36) DO outputs on signal.

F5 Group input terminals

F5 - 00 XI terminal function selection	0~60 [1]
F5 - 01x2 terminal function selection	0~60 [2]
F5 - 02 x3 terminal function selection	0~60 [9]
F5 - 03x4 terminal function selection	0~60 [12]
F5 - 04x5 terminal function selection	0~60 [13]
F5 - 05x6 terminal function selection	0~60 [14]

F5 – 06 X7 terminals function selection	0 ~ 60 [8]
---	------------

These parameters are used to set the functions of the digital multi-function input terminals and the functions that can be selected are shown in the following table:

Setting value	Functionalities	Description
0	Nonfunctional	The unused terminals can be set to "no function" to prevent misoperation.
1	Forward run (FWD)	The forward rotation and reverse rotation of the frequency inverter are controlled through external terminals.
2	Reverse run (REV)	
3	Three - wire operation control	Through this terminal, it is determined that the frequency inverter operation mode is a three-wire control mode. Please refer to the description of function code F5 - 11 ("terminal command method") for details.
4	Forward JOG (FJOG)	FJOG is JOG forward rotation, RJOG is JOG reverse rotation. Refer to the function code for JOG operation frequency and JOG acceleration / deceleration time description of F6 - 13, F6 - 14, F6 - 15.
5	Reverse JOG (RJOG)	
6	Terminal UP	The increment and decrement instructions of the frequency are modified when the frequency is given by the external terminal. When the frequency source is set to digital setting, the setting frequency of the section can be adjusted up and down.
7	Terminal DOWN	
8	Free parking	The frequency inverter blocks the output. At this time, the stop process of the motor is not controlled by the frequency changer.
9	Fault reset (RESET)	The function of using terminals to reset faults. Same function as reset key on keyboard. This function can be used to reset the remote fault barrier.
10	Suspension of operation	The frequency inverter decelerates and stops, but all operating parameters are memorized. Such as PLC parameters, swing frequency parameters and PID parameters. After this terminal signal disappears, the frequency inverter returns to the operating state before parking.
11	External fault normally open input	When the signal is sent to the frequency inverter, the frequency inverter reports the failure ETF.
12	Multi-segment command terminal 1	The speed of 16 segments can be realized through 16 States of the four terminals. See attached table 1 for details.
13	Multi-segment command terminal 2	
14	Multi-segment command terminal 3	
15	Multi-segment command terminal 4	
16	Acceleration and deceleration time selection terminal 1	Through the four States of the two terminals, the choice between the four acceleration and deceleration times can be realized, see table 2 for details.
17	Acceleration and deceleration time selection terminal 2	
18	Frequency source switching	Used to switch and select different frequency sources. According to the setting of the frequency source selection function code (F0 - 32); this terminal is used to switch between two frequency sources when switching between two frequency sources is set as the frequency source.
19	UP/DOWN setting cleared (terminal, keyboard)	When the frequency is given as a digital frequency, this terminal can clear the frequency value changed by the terminal UP/DOWN or the keyboard UP/DOWN to restore the given frequency to the value set in F0 - 09.

Setting value	Functionalities	Description
20	Control command switching terminal 1	When the command source is set to terminal control (F0 - 02 = 1), this terminal can switch between terminal control and keyboard control. When the command source is set to communication control (F0 - 02 = 2), this terminal can switch between communication control and keyboard control.
21	Acceleration and deceleration prohibition	Ensure that the frequency inverter is not affected by external signals (except shutdown command) and maintain the current output frequency.
22	PID pause	The PID is temporarily disabled; the frequency inverter maintains the current output frequency and no longer performs PID adjustment of the frequency source.
23	PLC status reset	The PLC is suspended during the execution process. When the PLC runs again, the frequency inverter can be restored to the initial state of the simple PLC through this terminal.
24	The pendulum frequency suspended	The frequency inverter outputs at the center frequency. The frequency swing function is suspended.
25	Counter input	Input terminal of counting pulse.
26	Counter reset	The counter status is cleared.
27	Length count input	Input terminal for length count.
28	Length reset	Length zero clearing
29	Torque control prohibited	It is forbidden for the frequency inverter to carry out torque control, and the frequency inverter enters the speed control mode.
30	PULSE (Pulse) frequency input (valid only for X5)	X5 functions as a pulse input terminal.
31	Reserve	Reserve
32	Immediate DC braking	When this terminal is active, the frequency inverter switches directly to the DC braking state
33	External fault normally closed input	When the normally closed signal of an external fault is sent to the frequency inverter, the frequency inverter reports the fault ETF and stops the operation.
34	Frequency modification prohibition	If this function is set to active, when the frequency changes, the frequency inverter will not respond to the frequency change until the terminal status is active.
35	The direction of PID action is reversed	When this terminal is active, the direction of PID action is opposite to the direction set by FA - 03
36	External parking terminal 1	When the keyboard is controlled, this terminal can be used to stop the frequency inverter, which is equivalent to the function of the STOP key on the keyboard.
37	Control command switching terminal 2	Used for switching between terminal control and communication control. If the source is selected as terminal control, the system will switch to communication control when the terminal is active; on the contrary, it is also the opposite.
38	PID integral suspended	When this terminal is valid, the integral adjustment function of the PID is suspended, but the proportional adjustment and differential adjustment functions of the PID are still valid.
39	Frequency source X switches to preset frequency	If the terminal is valid, the frequency source X is replaced by a preset frequency (F0 - 09)
40	Frequency source Y switches to preset frequency	This terminal is valid, then the frequency source Y is replaced by a preset frequency (F0 - 09)

Setting value	Functionalities	Description
41	Motor selection terminal 1	2 sets of motor parameters can be switched through the 2 states of terminals, see table 3 for details.
42	Reserve	Reserve
43	PID parameter switching	When the PID parameter switching condition is X terminal (FA - 18 = 1), when the terminal is invalid, the PID parameters are FA - 05 ~ FA - 07; When the terminal is valid, FA - 15 ~ FA - 17 will be used.
44	User - defined fault 1	When user-defined faults 1 and 2 are valid, the frequency inverter alarms UEF1 and UEF2 respectively.
45	User - defined fault 2	
46	Speed control / torque control switching	It causes the inverter to switch between torque control and speed control modes. When this terminal is invalid, the inverter operates in the mode defined by F7 - 00 (speed / torque control mode), and when this terminal is valid, it switches to another mode. During operation, switching can be carried out through terminals, which will take effect immediately after switching
47	Emergency stop	When the terminal is valid, the frequency inverter stops at the fastest speed, and the current is at the upper limit set during the stop. This function is used to meet the requirement that the frequency inverter needs to be shut down as soon as possible when the system is in an emergency.
48	External parking terminal 2	Under any control mode (panel control, terminal control, and communication control), this terminal can be used to slow down and stop the frequency inverter. The deceleration time at this time is fixed at deceleration time 4.
49	Deceleration DC brake	When this terminal is active, the frequency inverter will first slow down to the stop DC brake starting frequency and then switch to the DC brake state.
50	This run time is cleared	When this terminal is valid, the timing time of this operation of the frequency inverter is cleared. This function needs to be used in conjunction with the timing operation (F8 - 04) and the arrival of this operation time (F8 - 07).
51	Two - wire / three-wire switching	For switching between two-wire and three-wire control. If F5 - 11 is two-wire type 1, switch to three-wire type 1 when the terminal function is valid. And so on.
52	Prohibition of reversal	This terminal is valid, and frequency inverter reversal is prohibited. Same function as F0 - 04.

Four multi-segment command terminals can be combined into 16 States, each of which corresponds to 16 command settings. Specific as shown in table 1:

Attached table 1 multi-paragraph instruction function description

K4	K3	K2	K1	Command setting	Corresponding parameter
OFF	OFF	OFF	OFF	Multi - segment instruction 0	FC-00
OFF	OFF	OFF	ON	Multi - segment instruction 1	FC-01
OFF	OFF	ON	OFF	Multi - segment instruction 2	FC-02
OFF	OFF	ON	ON	Multi - segment instruction 3	FC-03
OFF	ON	OFF	OFF	Multi - segment instruction 4	FC-04

K4	K3	K2	K1	Command setting	Corresponding parameter
OFF	ON	OFF	ON	Multi - segment instruction 5	FC-05
OFF	ON	ON	OFF	Multi - segment instruction 6	FC-06
OFF	ON	ON	ON	Multi - segment instruction 7	FC-07
ON	OFF	OFF	OFF	Multi - segment instruction 8	FC-08
ON	OFF	OFF	ON	Multi - segment instruction 9	FC-09
ON	OFF	ON	OFF	Multi - segment instruction 10	FC-10
ON	OFF	ON	ON	Multi - segment instruction 11	FC-11
ON	ON	OFF	OFF	Multi - segment instruction 12	FC-12
ON	ON	OFF	ON	Multi - segment instruction 13	FC-13
ON	ON	ON	OFF	Multi - segment instruction 14	FC-14
ON	ON	ON	ON	Multi - segment instruction 15	FC-15

When the frequency source is selected as multi-segment speed, 100.0 % of the function codes FC - 00 ~ FC - 15 correspond to the maximum frequency F0 - 16. In addition to being a multi-stage speed function, multi-stage instructions can also be used as a given source of PID or as a voltage source for VF separation control, etc. to meet the need of switching between different given values.

Table 2 description of terminal function for acceleration and deceleration time selection

Terminal 2	Terminal 1	Selection of acceleration or deceleration time	Corresponding parameter
OFF	OFF	Acceleration time 1	F0-10, F0-11
OFF	ON	Acceleration time 2	F6-17,F6-18
ON	OFF	Acceleration time 3	F6-19,F6-20
ON	ON	Acceleration time 4	F6-21,F6-22

Attached table 3 motor selection terminal function description

Terminal 2	Terminal 1	Motor selection
OFF	OFF	Motor 1
OFF	ON	Motor 2

F5 - 10 X input terminal filtering time	0.000s~1.000s [0.010s]
---	------------------------

Set software filtering time for X terminal status. If the input terminal is easily interfered and causes misoperation in use, this parameter can be increased to enhance the anti-interference ability.

However, the increase in the filtering time will cause the response of the X terminal to slow down.

F5 - 11 terminal command mode	0~3 [0]
-------------------------------	---------

This parameter defines four different ways to control the operation of the frequency inverter through external terminals.

Note: for convenience of explanation, the X1, X2 and X3 terminals among the X1 - X7 multifunction input terminals are randomly selected as external terminals. That is, the functions of X1, X2 and X3 terminals are selected by setting the values of F5 - 00 to F5 - 02. See the setting range of F5 - 00 to F5 - 06 for detailed function definition.

0: two-wire mode 1: this mode is the most commonly used two-wire mode. The forward and reverse rotation of the motor is determined by terminals x1 and x2.

The function code is set as follows:

Function code	Name	Setting value	Functional description
F5-11	Terminal command mode	0	Two - wire type 1
F5-00	X1 terminal function selection	1	Forward run (FWD)
F5-01	X2 terminal function selection	2	Reverse run (REV)

K1	K2	Operating instructions
1	0	Forward
0	1	Reversal
1	1	Stop
0	0	Stop

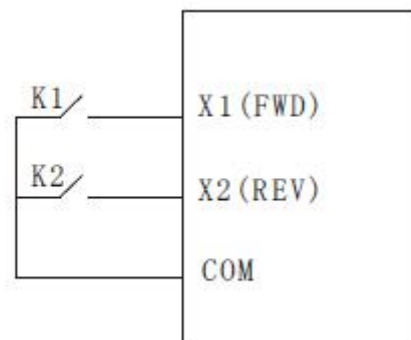

Figure 5 - 12 two-wire modes 1

As shown in the above figure, in this control mode, k1 is closed and the frequency inverter is running forward. K2 closes and reverses, k1 and k2 close or open at the same time, and the frequency inverter stops running.

1: two-wire mode 2: with this mode, the x1 terminal function is the operation enable terminal, while the x2 terminal function determines the direction of operation.

The function code is set as follows:

Function code	Name	Setting value	Functional description
F5-11	Terminal command mode	1	Two - wire type 2
F5-00	X1 terminal function selection	1	Operation enable
F5-01	X2 terminal function selection	2	Positive and negative direction of operation

K1	K2	Operating instructions
1	0	Forward
1	1	Reversal
0	1	Stop
0	0	Stop

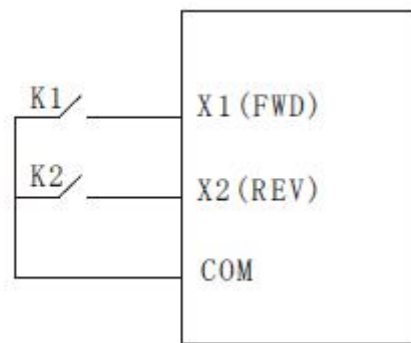

Figure 5 - 12 two-wire modes 2

As shown in the above figure, in this control mode, k2 opens the frequency inverter for forward rotation and k2 closes the frequency inverter for reverse rotation in the k1 closed state. K1 is disconnected and the frequency inverter stops running.

2: Three-wire control mode 1: this mode X3 is an enable terminal, and the directions are controlled by x1 and X2 respectively.

The function code is set as follows:

Function code	Name	Setting value	Functional description
F5-11	Terminal command mode	2	Three wire type 1
F5-00	X1 terminal function selection	1	Forward run (FWD)
F5-01	X2 terminal function selection	2	Reverse run (REV)
F5-02	X3 terminal function selection	3	Three - wire operation control

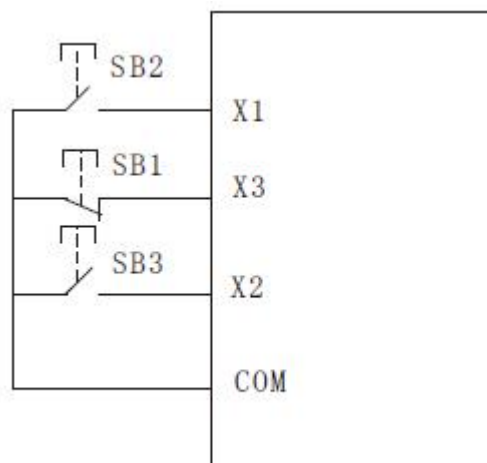

Figure 5 - 14 three-wire control modes 1

As shown in the above figure, the control mode is in the closed state of SB1 button, press SB2 button to rotate the frequency inverter forward, press SB3 button to rotate the frequency inverter reversely, and the sb1 button opens and the frequency inverter stops at the moment. During normal start-up and operation, it is necessary to keep the SB1 button closed. The commands of SB2 and SB3 buttons will take effect at the closing action edge and the operating state of the frequency inverter will be subject to the last key action of the three buttons.

3.3 - wire control mode 2:X3 in this mode is the enable terminal, the operation command is given by X1, and the direction is given by X1 the status of X2 is determined.

The function code is set as follows

Function code	Name	Setting value	Functional description
F5-11	Terminal command mode	3	Three wire type 2
F5-00	X1 terminal function selection	1	Operation enable
F5-01	X2 terminal function selection	2	Positive and negative direction of operation
F5-02	X3 terminal function selection	3	Three - wire operation control

K	Direction of movement
0	Forward
1	Reversal

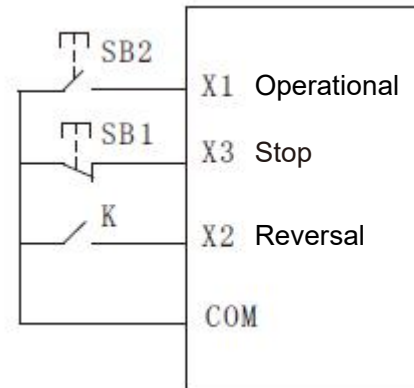

Figure 5 - 15 three-wire control modes 2

As shown in the figure above, the control mode is under the closed state of SB1 button, press the SB2 button converter to run, K turns off the inverter and K closes the inverter. SB1 button turns off and the frequency inverter stops immediately. During normal start-up and operation, it is necessary to keep the SB1 button closed, and the SB2 button command will take effect at the edge of the closing action.

F5 - 12 terminal UP/DOWN change rate	0.01Hz/s~65.535Hz/s [1.00Hz/s]
--------------------------------------	--------------------------------

When setting terminal UP/DOWN to adjust the set frequency, the speed of frequency changes, that is, the amount of frequency change per second.

F5 - 13 PULSE minimum input	0.00kHz~F5-15 [0.00HZ]
F5 - 14 PULSE minimum input corresponding settings	-100.0%~100.0% [0.00HZ]
F5 - 15 PULSE maximum input	F5-13~50.00KHZ [50.00KHZ]
F5 - 16 PULSE maximum input corresponding settings	-100.0%~100.0% [100.0%]
F5 - 17 PULSE filter time	0.00s~10.00s [0.01s]

This set of function codes is used to set the relationship between X5 pulse frequency and corresponding settings.

The pulse frequency can only be input to the frequency inverter through X5 channel.

F5 - 18 X1 delay time	0.0s~3600.0s [0.00S]
F5 - 19 X2 delay time	0.0s~3600.0s [0.00S]

F5 - 20 X3 delay time	0.0s~3600.0s [0.00S]
-----------------------	----------------------

Used to set the delay time for the change of X terminal state by the frequency inverter at present, only X1, X2, X3 have the function of setting the delay time.

F5 - 21 X terminal active mode selection 1	00000~11111 [00000]
--	---------------------

Bit: x1 terminal logic set to

0: positive logic

1. Inverse logic

10 bits: X2 terminal valid state setting (0 ~ 1, ditto)

100 bits: X3 terminal valid state setting (0 ~ 1, ditto)

1000 bits: X4 terminal valid state setting (0 ~ 1, ditto)

10,000 bits: X5 terminal valid state setting (0 ~ 1, ditto)

When positive logic is selected, the corresponding X terminal is valid when connected to com, and disconnection is invalid.

If it is selected as anti-logic valid, the corresponding X terminal will not be valid if it is connected to com, and the disconnection will be valid.

F5 - 22 X terminal active mode selection 2	00000~11111 [00000]
--	---------------------

Bit: X6 terminal logic set to 0: positive logic

1: inverse logic

10 bits: x7 terminal active state setting (0 ~ 1, same as above)

When positive logic is selected, the corresponding X terminal is valid when connected to com, and disconnection is invalid.

If it is selected as anti-logic valid, the corresponding X terminal will not be valid if it is connected to com, and the disconnection will be valid.

F5 - 24 AI curve 1 min input	0.00V~F5-26 [0.00V]
F5 - 25 AI curve 1 minimum input corresponding settings	-100.0%~100.0% [0.0%]
F5 - 26 AI curve 1 maximum input	F5-24~10.00V [10.00V]
F5 - 27 AI curve 1 maximum input corresponding settings	-100.0%~100.0% [100.0%]
F5 - 28 AI1 filtering time	0.00s~10.00s [0.10s]

The above function code is used to set the relationship between the analog input voltage and the set value it represents.

When the voltage of analog input is greater than the set "maximum input" (F5 - 26), the analog voltage is calculated according to "maximum input". Similarly, when the analog input voltage is less than the set " minimum input" (F5 - 24), it is calculated as the minimum input or 0.0 % based on the setting of " AI is lower than the minimum input setting selection" (F5 - 40).

When the analog input is a current input, 1ma current is equivalent to 0.5v voltage.

AI1 input filtering time is used to set the software filtering time of AI1. When the analog quantity in the field is easily interfered, please increase the filtering time to stabilize the detected analog quantity. However, the larger the filtering time is, the slower the response speed to the analog quantity detection will be. How to set it needs to be weighed according to the actual application situation

In different applications, the meaning of the nominal value corresponding to 100.0 % set by simulation is different. Please refer to the description of each application section for details.

The following illustrations show two typical settings:

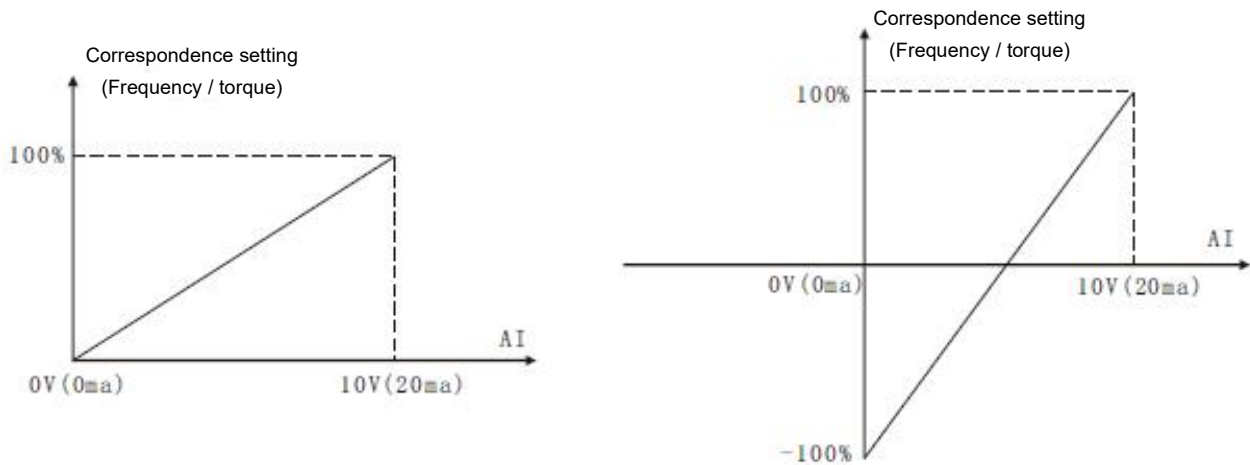

Figure 5 - 16 simulates the correspondence between a given value and a set value

F5 - 29 AI curve 2 minimum input	0.00V~F5-31 [0.00V]
F5 - 30 AI curve 2 minimum input corresponding settings	-100.0%~100.0% [0.0%]
F5 - 31 AI curve 2 maximum input	F5-29~10.00V [10.00V]
F5 - 32 AI curve 2 maximum input corresponding settings	-100.0%~100.0% [100.0%]
F5 - 33 AI2 filtering time	0.00s~10.00s [0.10s]

For the function and usage of curve 2, please refer to the description of curve 1.

F5 - 34 AI curve 3 minimum input	0.00V~F5-36 [0.00V]
F5 - 35 AI curve 3 minimum input corresponding settings	-100.0%~100.0% [0.0%]
F5 - 36 AI curve 3 maximum input	F5-34~10.00V [10.00V]
F5 - 37 AI curve 3 maximum input corresponding settings	-100.0%~100.0% [100.0%]
F5 - 38 AI3 filtering time	0.00s~10.00s [0.10s]

For the function and usage of curve 3, please refer to the description of curve 1.

F5 - 39 AI curve selection	111~555 [321]
----------------------------	---------------

Bit: curve selection corresponding to AI1

- 1: Curve 1 (2 - point curve, see F5 - 24 ~ F5 - 27)
- 2: Curve 2 (2 - point curve, see F5 - 29 ~ F5 - 32)
- 3: Curve 3 (2 - point curve, see F5 - 34 ~ F5 - 37)
- 4: Curve 4 (4 - point curve, see F5 - 41 ~ F5 - 48)
- 5: Curve 5 (4 - point curve, see F5 - 49 ~ F5 - 56)

10 bits: the curve corresponding to AI2 are selected to be

1 - 5 and are the same as the individual bits.

100 bits: the curves corresponding to AI3 are selected to be

1 - 5 and are the same as the individual bits.

Notes:

The individual bit, ten bits and hundred bits of the function code are respectively used for selection, and analog input AI1, AI2 and AI3 correspond to the set curves. 3 analog quantity input can select any one of the five curves. Curve 1, curve 2, and curve 3 are all 2 - Point curve, while curve 4 and curve 5 are both 4 - point curves.

F5 - 40 AI is lower than the minimum input setting selection	000~111 [000]
--	---------------

Bit: AI1 is lower than the minimum input setting selection

0: corresponds to minimum input settings.

1: 0.0%

If it is less than the minimum input, 0.0 % is considered as input.

10 bits: AI2 is lower than the minimum input setting and the definitions of 0~1 is the same as the individual bits.

10 bits: AI3 is lower than the minimum input setting and the definitions of 0~1 is the same as the individual bits.

This function code is used for setting, when the voltage of analog quantity input is less than the set "minimum input", how to determine the setting corresponding to analog quantity input.

The individual, ten and hundred bits of the function code correspond to analog quantity inputs AI1, AI2 and AI3, respectively.

If 0 is selected, when the AI input is lower than the "minimum input", the corresponding setting of the analog quantity is the function code.

Determined curve "minimum input corresponding settings" (F5 - 25, F5 - 30, F5 - 35). If 1 is selected, when the AI input is lower than the minimum input, the corresponding setting of the analog quantity is 0.0 %.

F5 - 41 AI curve 4 minimum input	0.00V~F5-43 [0.00V]
F5 - 42 AI curve 4 minimum input corresponding settings	-100.0%~100.0% [0.0%]
F5 - 43 AI curve 4 inflection point 1 input	F5-41~F5-45V [3.00V]
F5 - 44 AI curve 4 inflection point 1 input corresponding settings	-100.0%~100.0% [30.0%]
F5 - 45 AI curve 4 inflection point 2 input	F5-43~F5-47 [6.00V]
F5 - 46 AI curve 4 inflection point 2 input corresponding settings	-100.0%~100.0% [60.0%]
F5 - 47 AI curve 4 maximum input	F5-29~10.00V [10.00V]
F5 - 48 AI curve 4 maximum input corresponding settings	-100.0%~100.0% [100.0%]
F5 - 49 AI curve 5 min input	0.00V~F5-51 [0.00V]
F5 - 50 AI curve 5 minimum input corresponding settings	-100.0%~100.0% [0.0%]
F5 - 51 AI curve 5 inflection point 1 input	F5-49~F5-53V [3.00V]
F5 - 52 AI curve 5 inflection point 1 input corresponding settings	-100.0%~100.0% [30.0%]
F5 - 53 AI curve 5 inflection point 2 input	F5-51~F5-55 [6.00V]

F5-54 AI curve 5 inflection point 2 input corresponding settings	-100.0%~100.0% 【60.0%】
F5-55 AI curve 5 maximum input	F5-53~10.00V 【10.00V】
F5-56 AI curve 5 maximum input corresponding settings	-100.0%~100.0% 【100.0%】

The functions of curve 4 and curve 5 are similar to those of curve 1 to curve 3, but curve 1 to curve 3 are 2 - point straight lines, while curve 4 and curve 5 are 4 - point curves, which can realize more flexible correspondence. Figs. 5 - 17 are schematic diagrams of curves 4 to 5, taking curve 4 as an example.

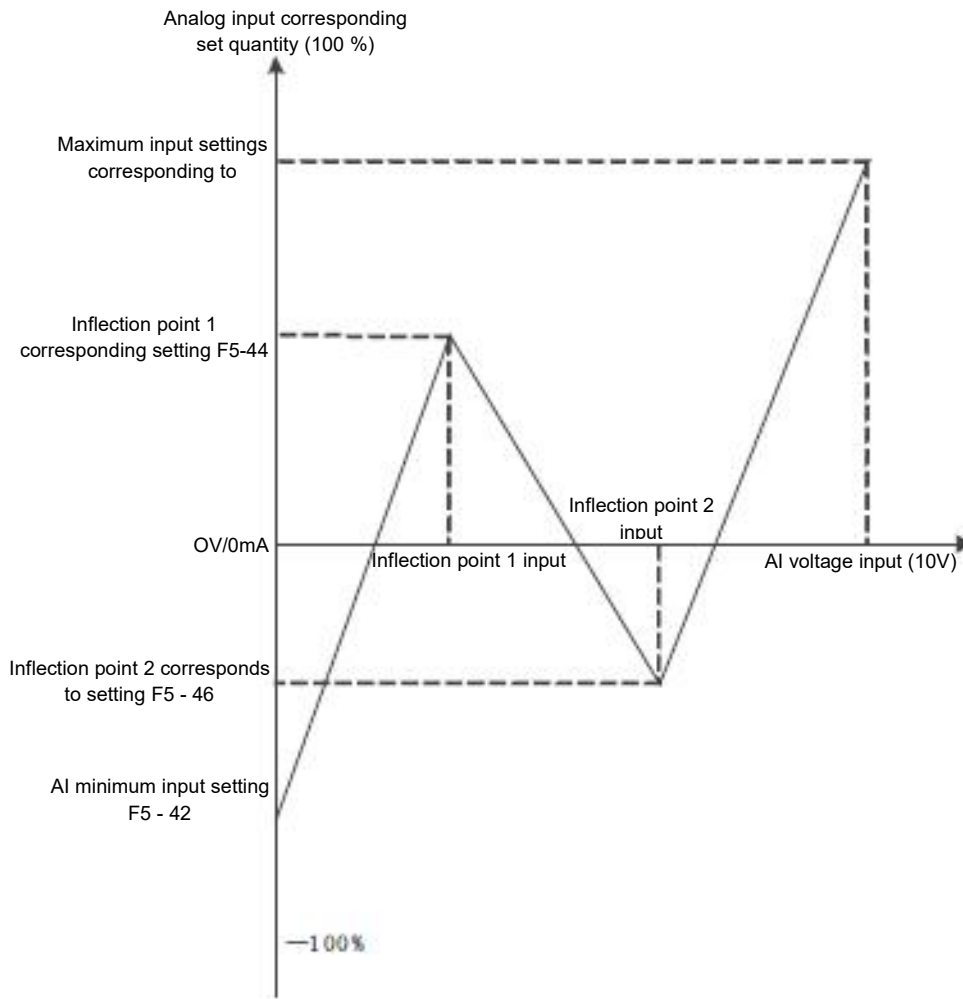

Figure 5 - 17 schematic diagram of 4 - point curve

Notes:

When setting curve 4 and curve 5, you should pay attention to the following conditions: minimum input voltage of curve < inflection point 1 voltage < Inflection point 2 voltage < maximum voltage

F5-65 AI1 sets jumping point	-100.0%~100.0% 【0.0%】
F5-66 AI1 sets jump amplitude	0.0% - 100.0% 【0.5%】
F5-67 AI2 sets jumping point	-100.0%~100.0% 【0.0%】
F5-68 AI2 sets jump amplitude	0.0% - 100.0% 【0.5%】

F5-69 AI3 sets jumping point	-100.0%~100.0% 【0.0%】
F5-70 AI3 sets jump amplitude	0.0% - 100.0% 【0.5%】

Analog quantity inputs AI1 to AI3 have the function of setting value jump. The skip function refers to setting the analog quantity corresponding to changes in the upper and lower sections of the skip point.

The value is fixed to the value of the jumping point.

Example:

The voltage of analog quantity input AI1 fluctuates up and down 5.00V, ranging from 4.90V to 5.10V. the minimum input 0.00 V of AI1 corresponds to 0.0 % and the maximum input 10.00V corresponds to 100. %. And then the detected AI1 corresponds to a fluctuation of 49.0 % ~ 51.0 %.

Setting AI1 set jumping point F5 - 65 to 50.0 % and setting AI1 set jumping amplitude F5 - 66 to 1.0 %, the corresponding setting of the obtained AI1 input after the jump function processing is fixed to 50.0 %, AI1 is converted into a stable input and the fluctuation is eliminated.

F6 Group start-stop control

F6 - 00 starting operation mode	0~2 [0]
---------------------------------	---------

0: direct starting

If the starting DC braking time is set to 0, the frequency inverter will start operating from the starting frequency.

If the starting DC braking time is not 0, DC braking will be performed first, and then operation will start from the starting frequency. Suitable for small inertia load, where the motor may rotate during start - up

1: speed tracking and restarting

The frequency inverter first judges the speed and direction of the motor, then starts at the tracked frequency of the motor, and during rotation the motor starts smoothly and without impact. It is suitable for the restart of large inertia load with instantaneous power failure. In order to ensure the performance of speed tracking and restart, it is necessary to accurately set the f1 parameters of the motor.

2: The pre-excitation starting of the asynchronous machine

Is only valid for the asynchronous motor, which is used to establish the magnetic field before the motor runs.

Refer to the description of function codes F6 - 05 and F6 - 06 for pre-excitation current and pre-excitation time.

If the pre-excitation time is set to 0, the frequency inverter cancels the pre-excitation process and starts from the starting frequency. If the pre-excitation time is not 0, the motor can be pre-excited before starting, which can improve the dynamic response performance of the motor.

F6 - 01 speed tracking method	0~2 [0]
-------------------------------	---------

In order to complete the speed tracking process in the shortest time, select the way that the frequency inverter tracks the motor speed:

0: starting from shutdown frequency

This method is usually used to track down from the frequency of power failure.

1: starting from zero speed

Track up from zero frequency, and use it in case of power failure for a long time before starting.

2: starting from the maximum frequency

Track down from the maximum frequency and use the general power generating load.

F6 - 02 rotational speed tracking speed	0~100 [20]
---	------------

When speed tracking is restarted, select the speed of speed tracking.

The larger the parameter, the faster the tracking speed. However, setting too large may lead to unreliable tracking results.

F6 - 03 startup frequency	0.00Hz~10.00Hz 【0.00Hz】
F6 - 04 startup frequency hold time	0.0s~100s 【0.0s】

In order to ensure the motor torque during starting, please set the appropriate starting frequency. In order to fully establish magnetic flux when starting the motor, it is necessary to keep the starting frequency for a certain period of time.

The relationship between starting frequency and starting time is shown in figure 5 - 18.

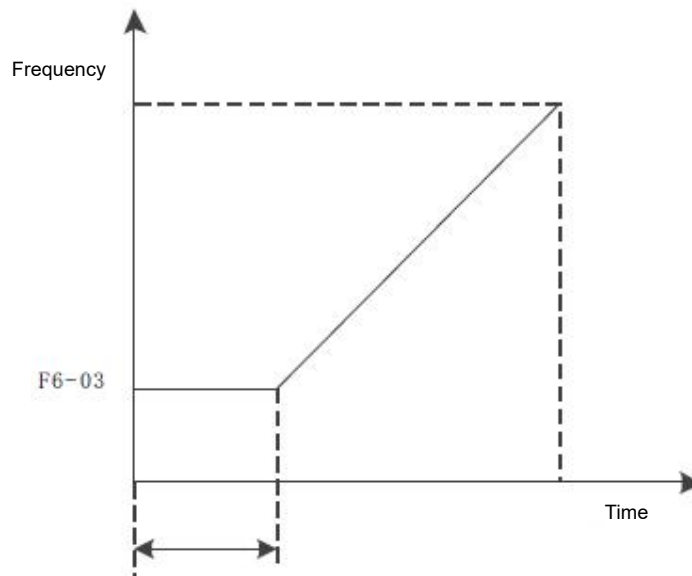

Figure 5 - 18 startup frequency and startup time

Notes:

The starting frequency F6 - 03 is not limited by the lower limit frequency.

When the set target frequency is less than the starting frequency, and the frequency inverter will not start and will be in standby mode.

During forward and reverse switching, the start frequency holding time does not work.

The startup frequency holding time is not included in the acceleration time, but is included in the operation time of the simple PLC.

F6-05 start DC brake current / pre-excitation current	0%~100% 【0%】
F6-06 start DC brake time / pre - excitation time	0.0s~100.0s 【0.0s】

Start the direct current brake, which is usually used to stop the running motor before starting. The pre-excitation is used to set up a magnetic field before starting the asynchronous motor to improve the response speed.

If it is valid when the startup mode is direct startup at this time, the frequency inverter performs direct current braking according to the set starting direct current braking current, and starts to run after the starting direct current braking time. If the DC braking time is set to 0, it will be started directly without direct current braking.

If the starting mode is asynchronous machine pre-excitation starting, the frequency inverter first establishes a magnetic field in advance according to the set pre-excitation current, and then starts to run after the set pre-excitation time. If the pre-excitation time is set to 0, it will be started directly without going through the pre-excitation process.

F6-07 stop DC brake starting frequency	0.00 Hz ~ maximum frequency [0.00 Hz]
F6-08 stop DC brake waiting time	0.0s~36.0s 【0.0s】
F6-09 stop DC brake current	0%~100% 【0%】
F6-10 stop DC braking time	0.0s~36.0s 【0.0s】

Stop DC brake starting frequency: during deceleration and stop, when the operating frequency drops to this frequency, the DC brake process starts.

Stop DC brake waiting time: after the operating frequency is reduced to the stop DC brake starting frequency, the frequency inverter stops output for a period of time before starting the DC brake process. It is used to prevent over-current and other faults that may be caused by starting DC braking at higher speeds

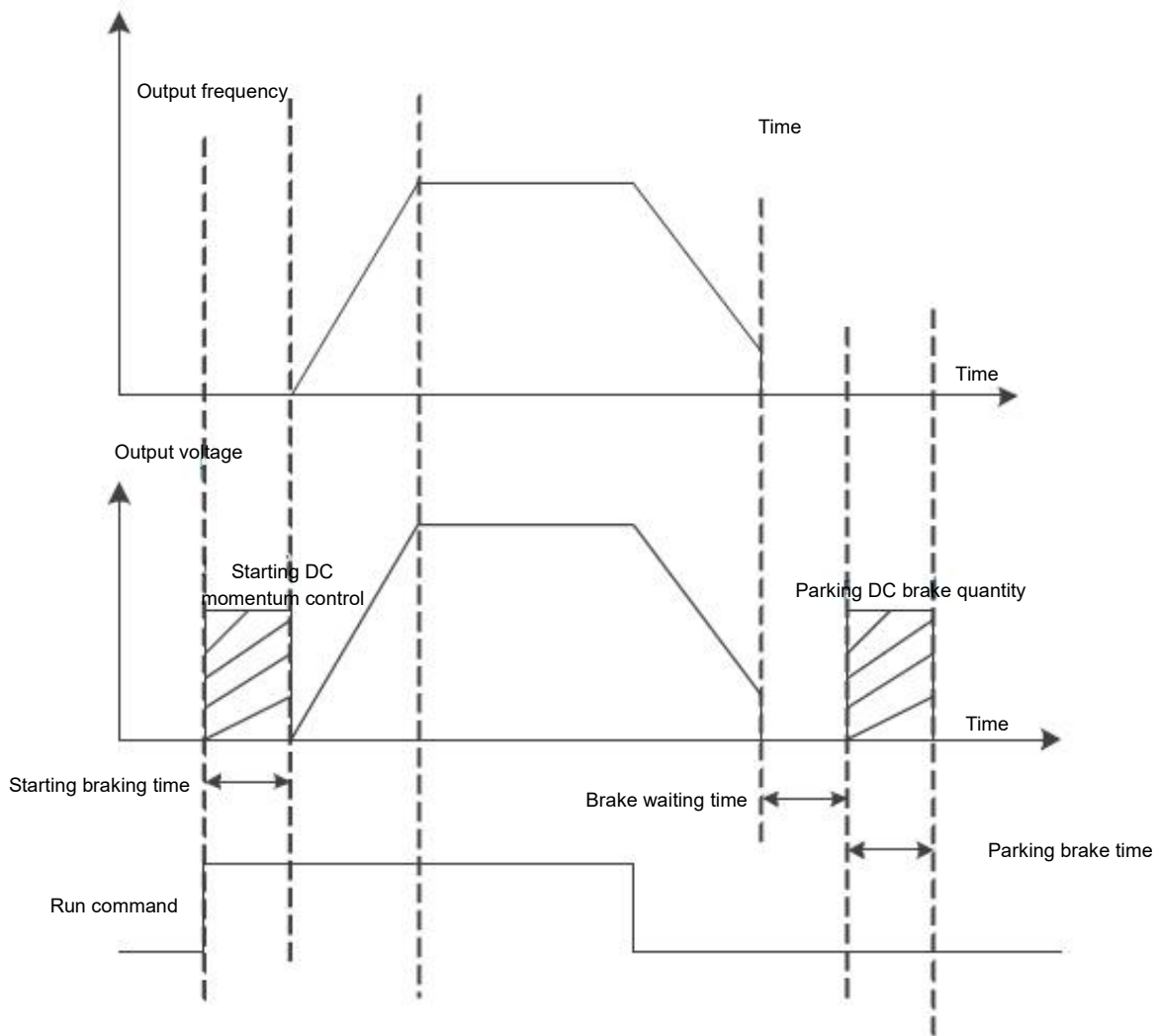

Figure 5 - 19 schematic diagram of DC braking

F6 - 11 brake usage rate	0%~100% 【100%】
--------------------------	----------------

Valid only for frequency inverter with built-in brake unit

It is used to adjust the duty ratio of the moving unit and if the brake usage rate is high, the duty ratio of the brake unit is high and the brake effect is strong, but the inverter bus voltage fluctuates greatly during braking.

Notes:

The setting of this function code should take into account the resistance and power of the braking resistor.

F6-13 JOG frequency	0.00 Hz ~ maximum frequency [2.00 Hz]
F6-14 JOG acceleration time	0.0s~6500.0s 【20.0s】
F6-15 JOG deceleration time	0.0s~6500.0s 【20.0s】

The given frequency and acceleration / deceleration time of the frequency inverter during define JOG.

During JOG operation, the starting mode is fixed as direct starting mode and the stopping mode is fixed as deceleration stopping mode.

F6 -16 terminal JOG takes precedence	0~1 【0】
--------------------------------------	---------

This parameter is used to set whether the terminal jog function has the highest priority.

When the terminal JOG takes precedence, if the terminal JOG command appears during operation, the frequency inverter will switch to the terminal point running status

F6 - 17 acceleration time 2	0.0s ~ 6500.0 S [model determination]
F6 - 18 deceleration time 2	0.0s ~ 6500.0 S [model determination]
F6 - 19 acceleration time 3	0.0s ~ 6500.0 S [model determination]
F6 - 20 deceleration time 3	0.0s ~ 6500.0 S [model determination]
F6 - 21 acceleration time 4	0.0s ~ 6500.0 S [model determination]
F6 - 22 deceleration time 4	0.0s ~ 6500.0 S [model determination]

HV610 has 4 groups of acceleration and deceleration times, which are F0 - 10 \ F0 - 11 and the above 3 groups of acceleration and deceleration times respectively.

The definitions of the four groups of acceleration and deceleration times are exactly the same, please refer to F0 - 10 and F0 - 11 related instructions.

Through different combinations of multifunctional digital input terminals x, four groups of acceleration and deceleration times can be switched and selected, and the specific user can please refer to the relevant instructions in function codes F5 - 01 ~ F5 - 05 for the method.

F6 -23 acceleration and deceleration mode	0~1 【0】
---	---------

Select the frequency change mode of the frequency inverter during start-up and stop - up.

0: the output frequency of linear acceleration and deceleration

Increases or decreases linearly according to a constant slope.

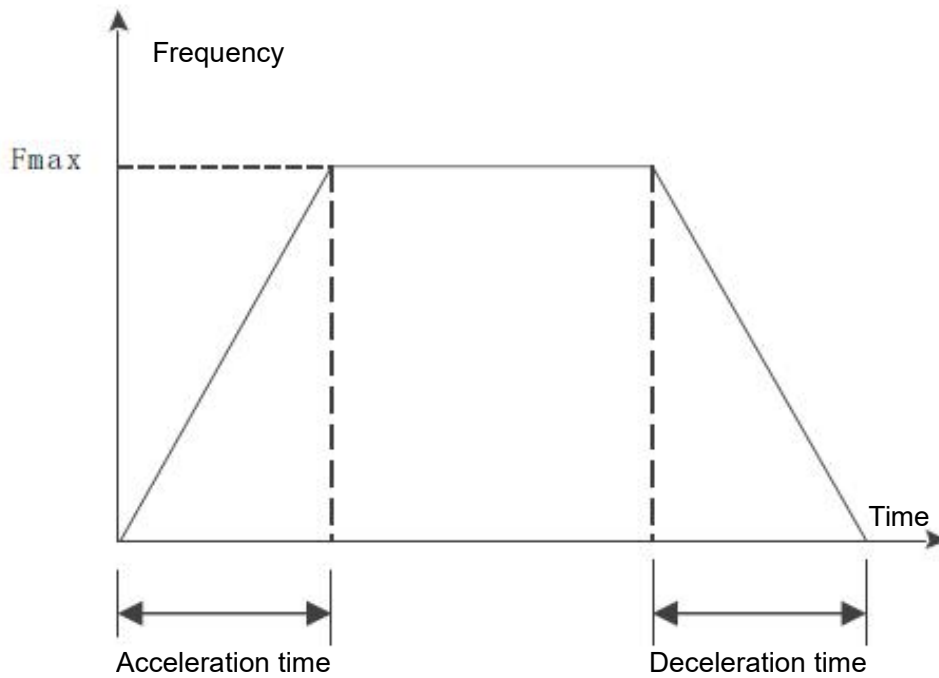

Figure 5 - 20 linear acceleration and deceleration

1: S curve acceleration and deceleration

The output frequency increases or decreases according to the S curve. The S curve is used in places that require gentle start-up or shutdown, such as electric ladders and conveyor belts. The function codes F6 - 24 and F6 - 25 define the time ratios of the start and end segments of the S - curve acceleration and deceleration respectively.

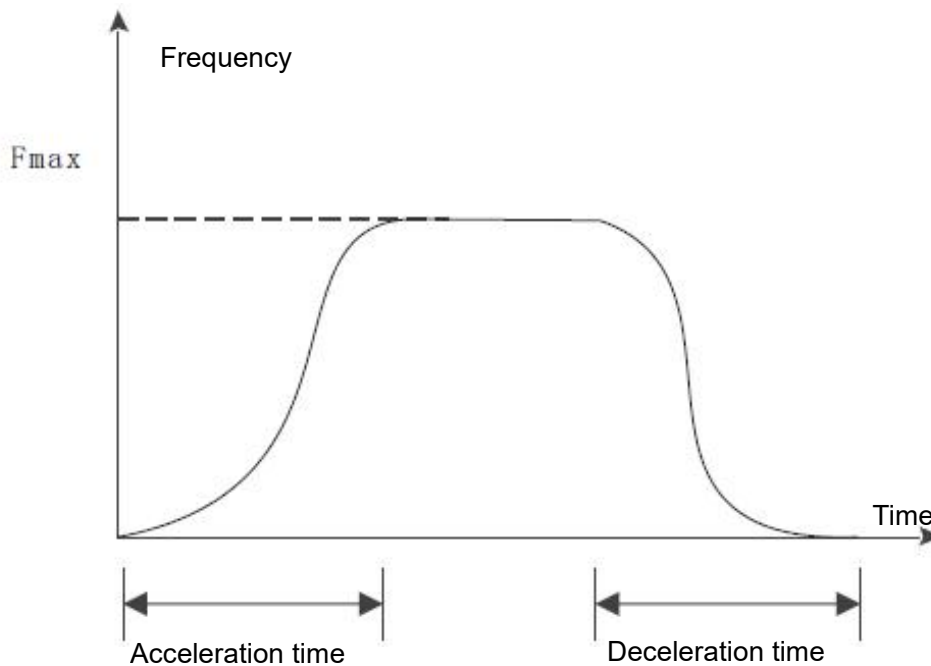

Figure 5 - 21 S curve acceleration and deceleration

F6 - 24 S curve start period time proportion	0%~0.0%~(100.0%-F6-25) 【30%】
F6 - 25 S curve end period time proportion	0%~0.0%~(100.0%-F6-26) 【30%】

The function codes F6 - 24 and F6 - 25 respectively define the time ratio between the start and end periods of the S curve acceleration and deceleration A and the two function codes shall meet the following requirements: $F6-24 + F6-25 \leq 100.0\%$

F6-26 acceleration time 1 and acceleration time 2 switch frequency points	0.00Hz ~ maximum frequency 【0.00hz】
F6-27 deceleration time 1 and deceleration time 2 switch frequency points	0.00Hz ~ maximum frequency 【0.00hz】

During acceleration, if the operating frequency is less than F6 - 26, the acceleration time 2 is selected; if the operating frequency is greater than F6 - 26, select acceleration time 1.

During deceleration, select deceleration time 1 if the operating frequency is greater than F6 - 27, and select deceleration time 1 if the operating frequency is less than F6 -27 and the deceleration time 2 is selected.

F7 Group torque control

F7 - 00 speed / torque control mode	0~1 【0】
-------------------------------------	---------

0: speed control mode.

1: torque control mode.

Notes:

The torque control mode is only valid in vector mode and VF control mode is invalid.

The X terminal has two functions related to torque control: torque control inhibits (function 29) and speed control / torque control switch (function 46). These two terminals should be used in conjunction with F7 - 00 to switch speed and torque control.

F7 - 01 torque setting selection under torque control mode	0~7 【0】
--	---------

F7 - 01 is used to select the torque setting source. There are 8 torque setting methods.

Torque setting uses relative value, 100.0 % corresponding to the rated torque of the motor. Setting range - 200.0 % ~ 200.0 %, table the maximum torque of the Ming frequency inverter is twice the rated torque of the frequency inverter.

When the torque is given to be positive, the frequency inverter is running in forward rotation

When the torque is given to be negative, the frequency inverter is running in reverse rotation

0: digital setting (F7 - 03)

Means that the target torque directly uses the F7 - 03 setting value.

1: AI1

2: AI2

3: AI3

Refers to the target torque is determined by the analog input terminal.

AI is given as torque, the voltage / current input corresponds to 100.0 % set, which refers to the percentage of F7 - 03 set with respect to the torque number.

4. PULSE pulse (X5)

Target torque is given through terminal X5 high speed pulse.

Pulse given signal specification: voltage range 9V~30V, frequency range 0kHz~100kHz. Pulse given can only be input from the multi-function input terminal X5.

The setting of 100.0 % corresponding to X5 terminal pulse input refers to the percentage of F7 - 03 set with respect to the torque figure.

5. Communication given

Refers to the target torque is given by means of communication.

The host computer gives the data through the communication address 0x1000, and the data format is - 100.00 % - 100.00 %. 100.00 % refers to the percentage set by F7 - 03 with respect to the torque figure.

F7 - 02 small torque stop compensation	-50.0%~50.0% 【0.0%】
--	---------------------

During torque control, the setting torque is too small to stop the traction load. At this time, F7 - 02 is added, and the setting goes bigger, and the greater the torque during shutdown (note: not deceleration).

F7 - 04 torque control speed limit source	0~1 【0】
---	---------

0: set speed limit by F7 - 05 and F7 - 06.

When the torque setting is greater than 0, the upper frequency limit is given by F7 - 05; When the torque setting is less than 0, the upper frequency limit is set by F7 - 06.

1: set by frequency source F0 - 03 frequency source.

When the torque is set to be 0, the upper frequency limit is determined by the frequency selected by F0 - 03. When the torque is set to be 0, the upper frequency limit is F0 - 03 negative number of selected frequency.

F7-05 Torque control forward maximum frequency	0.00Hz ~ maximum frequency 【50.00hz】
F7-06 Torque control reverse maximum frequency	0.00Hz ~ maximum frequency 【50.00hz】

During torque control, the acceleration / deceleration time of the upper frequency limit is set at F7 - 09 (acceleration) / F7 - 10 (deceleration).

Used to set the maximum forward or reverse operating frequency of the frequency inverter in torque control mode.

When the frequency inverter torque is controlled, if the load torque is less than the motor output torque, the motor speed will continuously increase. In order to prevent accidents such as speeding in mechanical systems, it is necessary to limit the maximum rotational speed of the motor during torque control.

If it is necessary to dynamically and continuously change the maximum frequency of torque control, the upper limit frequency can be controlled.

F7-07 Torque given rise time	0.00s~650.00s 【0.00s】
F7-08 Given torque drop time	0.00s~650.00s 【0.00s】

Under the torque control mode, the difference between the motor output torque and the load torque determines the speed change rate of the motor and the load. Therefore, the speed of the motor may change rapidly, which will cause problems such as noise or excessive mechanical stress. By setting the torque control acceleration and deceleration time, the rotation speed of the motor can be changed smoothly.

However, when torque is required to respond quickly, torque control acceleration and deceleration time should be set to 0.00s.

F7-09 Torque control frequency rise time	0.00s~6500.00s 【20.00s】
F7-10 Torque control frequency drop time	0.00s~6500.00s 【20.00s】

F8 Group auxiliary function

F8 - 00 cumulative power-on arrival time setting	0h~65000h 【0h】
--	----------------

When the accumulated power-on time (U0 - 71) reaches the power-on time set by F8 - 00, the frequency inverter multifunction (No. 24) digital DO outputs the on signal.

F8 - 01 cumulative run arrival time setting	0h~65000h 【0h】
---	----------------

When the accumulated operating time (U0 - 70) reaches this set operating time, the digital DO of the frequency inverter multifunction (No. 12) outputs the on signal.

F8 - 02 Selection of G/P machine	1~2 【1】
----------------------------------	---------

1: G machine

2: P machine

Note: when modifying this function code, the motor group parameters will change accordingly.

F8 - 04 timing function selection	0~1 【0】
-----------------------------------	---------

0: invalid

1: valid

F8 - 05 timing run time selection	0~3 【0】
-----------------------------------	---------

0: set by F8 - 06

1: set by AI1 (100 % analog input range corresponds to F8 - 06)

2: AI2 setting (100 % analog input range corresponds to F8 - 06)

3: AI3 setting (100 % analog input range corresponds to F8 - 06)

F8 - 02 = 4, the frequency inverter starts timing when it starts. After reaching the set timing running time, the frequency inverter stops automatically and the multi-function DO outputs an on signal at the same time.

Each time the frequency inverter starts, it starts counting from 0. The remaining running time of timing can be checked through u0 - 20.

The timing run time is set by F8 - 05 / F8 - 06 and the time unit is min.

F8-06 timing run time	0.0Min~6500.0Min 【0.0Min】
-----------------------	---------------------------

F8-07 arrival time setting for this run	0.0Min~6500.0Min 【0.0Min】
---	---------------------------

When the running time of this startup reaches this time, the multi-function digital DO of the frequency inverter outputs an on signal of "the running time reaches this time".

F8 - 08 skip frequency 1	0.00 Hz ~ maximum frequency [0.00Hz]
--------------------------	--

F8 - 09 skip frequency 2	0.00 Hz ~ maximum frequency [0.00Hz]
--------------------------	--

F8 - 10 skip frequency 3	0.00 Hz ~ maximum frequency [0.00Hz]
--------------------------	--

F8 - 11 skip frequency 4	0.00 Hz ~ maximum frequency [0.00Hz]
--------------------------	--

F8 - 12 jump frequency amplitude	0.00 Hz ~ maximum frequency [0.00Hz]
----------------------------------	--

F8 - 08 ~ F8 - 12 are designed for the output frequency of the frequency inverter to avoid the resonance point of the mechanical load.

When the set frequency is within the jump frequency range, the actual operating frequency will run in the jump closer to the set frequency. By setting the jumping frequency, the frequency inverter can avoid the mechanical resonance point of the load.

HV610 can set 4 hopping frequency points. If all 4 hopping frequencies are set to 0, the hopping frequency function will be cancelled.

The conditions that must be met: The principle of hopping frequency $1 \leq \text{hopping frequency } 2 \leq \text{hopping frequency } 3 \leq \text{hopping frequency } 4$

Hopping frequency and hopping frequency amplitude is illustrated herein with, please refer to figure 5 - 22.

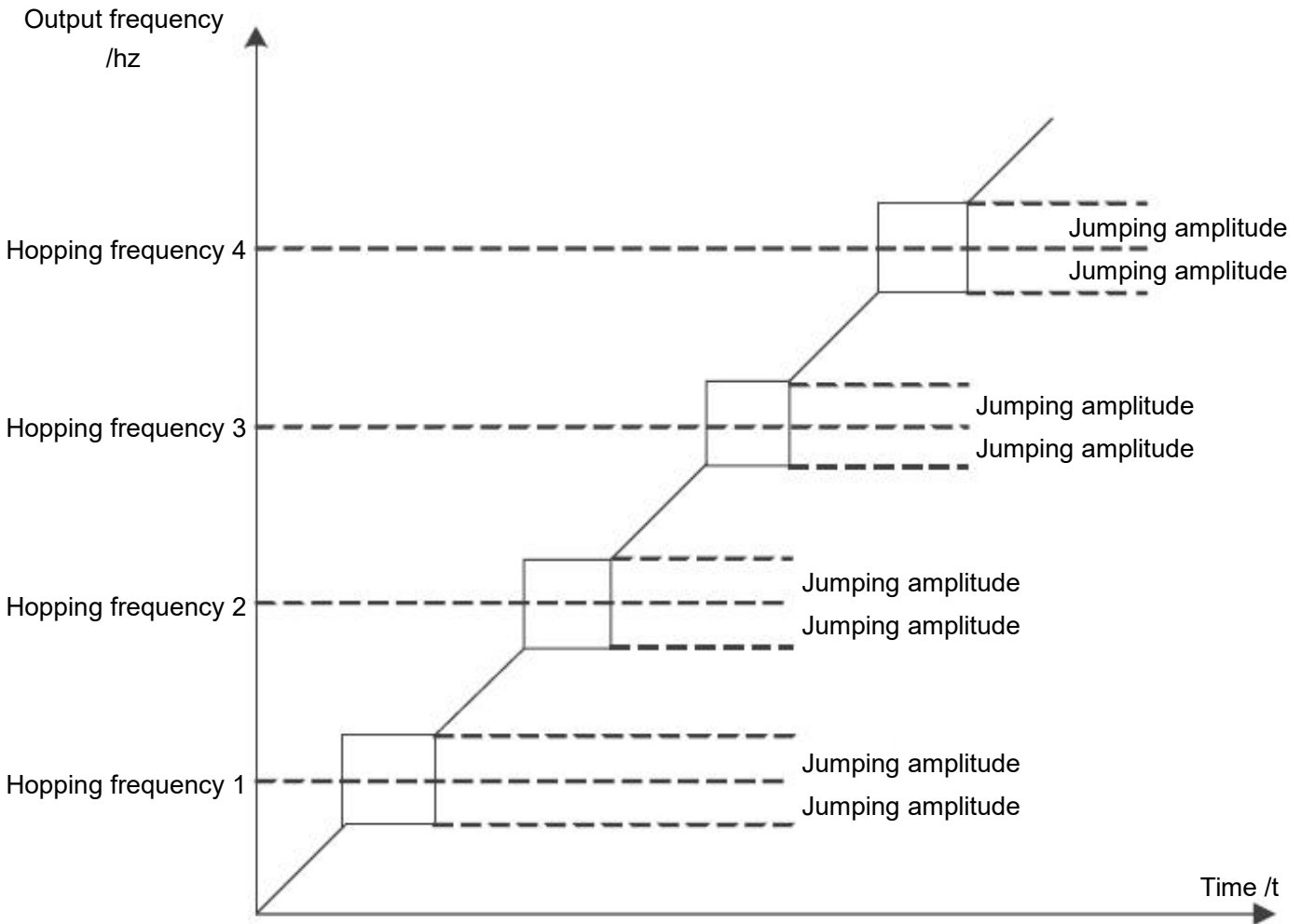

Figure 5 - 22 Hopping frequency diagram

F8 - 13 is the Hopping frequency valid during acceleration and deceleration	0~1 【0】
---	---------

This function code is used to set whether the skip frequency is valid during acceleration and deceleration.

F8 - 13 = 1, when the operating frequency is in the hopping frequency range, the actual operating frequency will skip the set hopping frequency boundary. Figure 5 - 23 is a schematic diagram showing the valid jumping frequency during acceleration and deceleration.

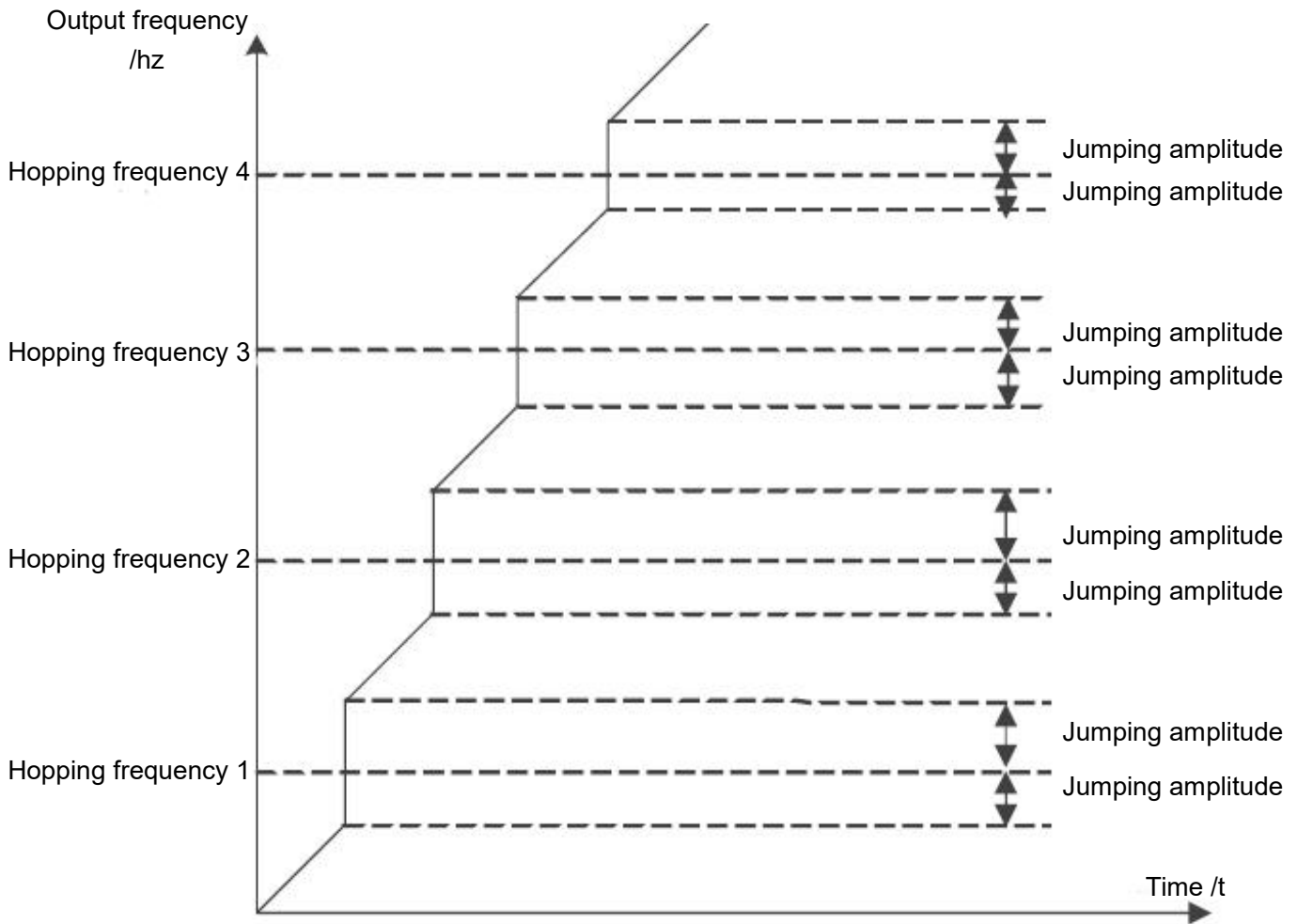

Figure 5 - 23 valid diagram of jumping frequency during acceleration and deceleration

F8-14 wakeup frequency	Sleep frequency (F8 - 16) - maximum frequency (F0 - 10) 【0.00HZ】
F8-15 wake - up and delay time	0.0s~6500.0s 【0.0S】
F8-16 sleep frequency	0.00 Hz ~ wakeup frequency (F8 - 14) [0.00 Hz]
F8-17 sleep delay time	0.0s~6500.0s 【0.0S】

This set of parameters is used to realize sleep and wake-up functions in water supply applications.

During the operation of the frequency inverter, when the set frequency is less than or equal to the F8 - 16 sleep frequency, the F8 - 17 delay time passes. After that, the frequency inverter goes to sleep and stops automatically.

If the frequency inverter is in sleep state and the current operation command is valid, when the set frequency is greater than or equal to F8 - 14 wake up Frequency, after a delay of time F8 - 15, the frequency inverter starts to start.

In general, please set the wakeup frequency to be greater than or equal to the sleep frequency. Set the wake-up frequency and sleep frequency to both 0.00 Hz, sleep and wake-up functions are invalid.

When the sleep function is enabled, if the frequency source uses PID, whether the sleep state PID is operated is determined by the function code FA - 28, at this time must choose PID downtime calculation (FA - 28 = 1).

Note: during sleep, the running LED on the control panel blinks for 1s

F8 - 18 output power correction factor	0.0%~200.0% 【100.0%】
--	----------------------

When the output power (u0 - 05) does not correspond to the expected value, the output power can be linearly corrected through this value.

F8 - 19 instantaneous power failure action selection	0~2 【0】
--	---------

In the event of an instantaneous power failure or a sudden drop in voltage, the frequency inverter compensates for the drop in DC bus voltage of the frequency inverter by reducing the output speed, so as to maintain the frequency inverter's continuous operation.

0: this function is invalid.

1: slow down.

When the power is cut off or the voltage drops suddenly, the frequency inverter slows down. When the bus voltage returns to normal, the frequency inverter is normal. Speed up recovery to set frequency operation. The basis for judging the bus voltage to return to normal is that the bus voltage is normal and the duration exceeds the set time of F8 - 21.

2: slow down and shut down.

In the event of an instantaneous power failure or a sudden drop in voltage, the frequency inverter slows down until it stops.

F8-20 momentary stop action pauses judgment voltage	80.0%~100.0% 【90.0%】
F8-21 judging time of instantaneous power failure voltage rebound	0.00s~100.00s 【0.50s】
F8-22 instantaneous power failure action judgment voltage	60.0 % ~ 100.0 % (standard bus voltage) [80.0 %]

F8 - 23 ~ F8 - 32 are specially designed for the textile industry. They are used in textile, chemical fiber and other industries, as well as in occasions where horizontal movement and winding functions are required. They are simply referred to as swing frequency functions.

The pendulum frequency function is applicable to the pendulum frequency function. It refers to the frequency output by the frequency inverter, which swings up and down around the set frequency. The track of the operating frequency on the time axis is shown in figure 5 - 24. The swing amplitude is set by F8 - 23 and F8 - 24. When F8 - 24 is set to 0, the pendulum frequency will not work at this time.

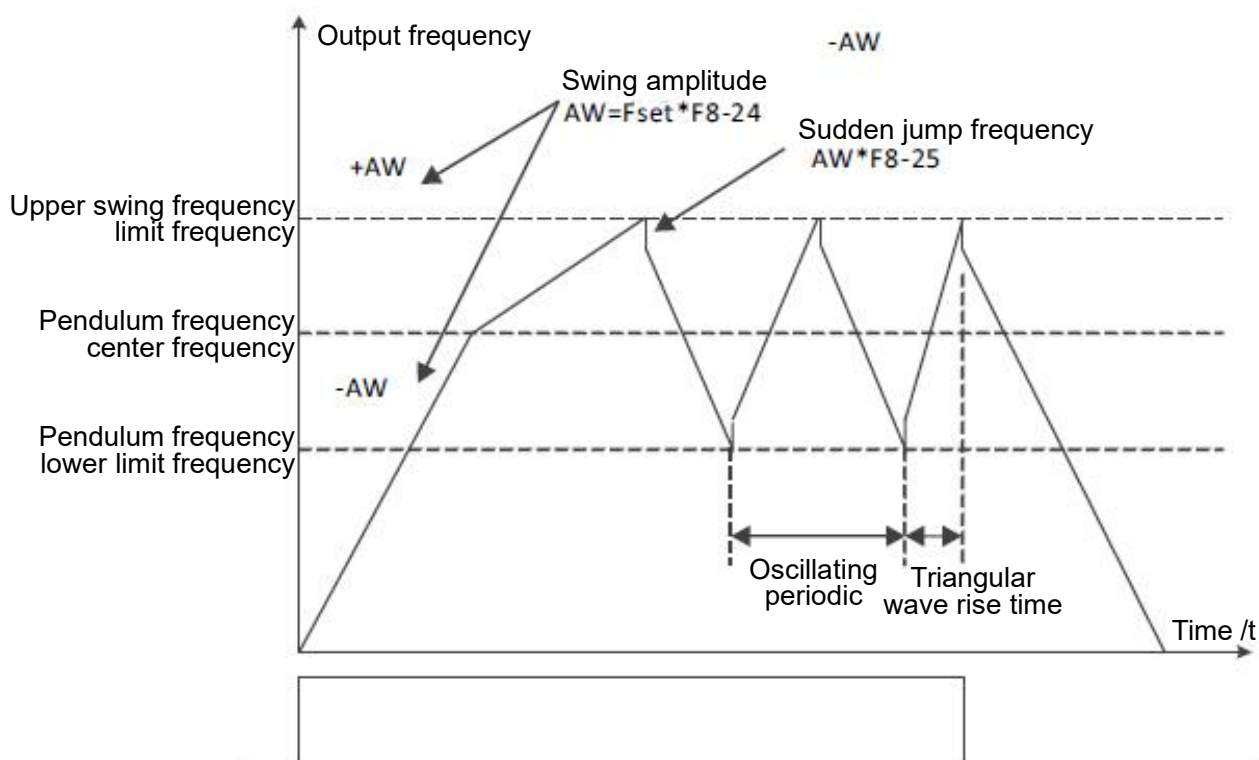

Figure 5 - 24 schematic diagram of swing frequency operation

F8 - 23 swing setting method	0~1 [0]
------------------------------	---------

This parameter is used to determine the reference amount of the swing.

0: relative center frequency (current frequency source), variable swing system. The swing amplitude changes with the change of the center frequency (set frequency).

1: the relative maximum frequency (F0 - 16) is a fixed swing system, and the swing is fixed.

F8 - 24 swing amplitude	0.0%~100.0% [0.0%]
F8 - 25 sudden jump frequency amplitude	0.0%~50.0% [0.0%]

This parameter is used to determine the values of swing amplitude and sudden jump frequency.

When setting the swing relative to the center frequency (F8 - 23 = 0), swing aw = setting frequency X swing amplitude F8 - 24.

When setting the swing relative to the maximum frequency (F8 - 23 = 1), the swing aw = maximum frequency F0 - 16 * swing amplitude F8-24.

The sudden jump frequency amplitude is the percentage of the sudden jump frequency relative to the swing amplitude when the swing frequency is running, i.e. sudden adjustment frequency = swing amplitude aw * sudden jump frequency amplitude F8 - 25.

If the swing amplitude is selected relative to the center frequency (F8 - 23 = 0), the sudden adjustment frequency is a change value.

If the swing amplitude is selected relative to the maximum frequency (F8 - 23 = 1), the sudden adjustment frequency is a fixed value.

The frequency of swing frequency operation is limited by the upper limit frequency and the lower limit frequency.

F8 - 26 frequency swing period	0.0s~3000.0s [10.0s]
F8 - 27 triangular wave rise time coefficient	0.0%~100.0% [50.0%]

Frequency swing period: the time value of a complete frequency swing period.

The triangular wave rise time coefficient F8 - 27 is the percentage of the triangular wave rise time relative to the wobble period F8 - 26.

Triangular wave rise time = frequency swing period F8 - 26 × triangular wave rise time coefficient F8 - 27 in seconds.

Triangle wave falling time = swing frequency period F8 - 26 × (1 - triangle wave rising time coefficient F8 - 27), in seconds.

F8-28 set length	0m~65535m [1000m]
F8-29 actual length	0m~65535m [0m]
F8-30 number of pulses per meter	0.1~6553.5 [100.0]

The above function code is used for fixed length control.

Length information needs to be collected through a multifunctional digital input terminal, and the number of pulses sampled by the terminal and the number of pulses per meter The actual length F8 - 29 can be calculated by dividing F8 - 30.

During the fixed length control process, the length reset operation can be performed through the multi-function X terminal (the X terminal function is selected as follows 28), please refer to F5 - 00 ~ F5 - 06 for details.

The corresponding input terminal function needs to be set to "length count input" (function 27) in the application. In the pulse frequency X5 port must be used when it is high.

F8 - 31 set count value	1~65535 [1000]
F8 - 32 specifies the count value	1~65535 [1000]

The count value needs to be collected through the multifunctional digital input terminal. The corresponding input terminal function needs to be set to "counter input" (function 25) in the application. When the pulse frequency is high, X5 port must be used.

When the count value reaches the set count value F8 - 31, the multifunction digital DO outputs the "set count value reaches" ON signal, and then the counter stops counting

When the count value reaches the specified count value F8 - 32, the multifunction digital DO outputs the "specified count value reaches" ON signal. At this time, the counter continues counting until "set count value" when the counter stops.

The specified count value F8 - 32 should not be greater than the set count value F8 - 31. The count value can be viewed in u0 - 12.

F9 Group failure and protection

F9 - 00 motor overload protection selection	0~1 [1]
F9 - 01 motor overload protection gain	0.20~10.00 [1.00]

F9 - 00 = 0: motor overload protection is invalid.

F9 - 00 = 1: at this time, the frequency inverter judges whether the motor is overloaded according to the inverse time limit curve of the motor overload protection.

The shortest time to report motor overload is 2 minutes. If you need to adjust motor overload current and time, please Set F9 - 01 (motor overload protection gain). The curve of motor overload current and overload time is shown in the following figure:

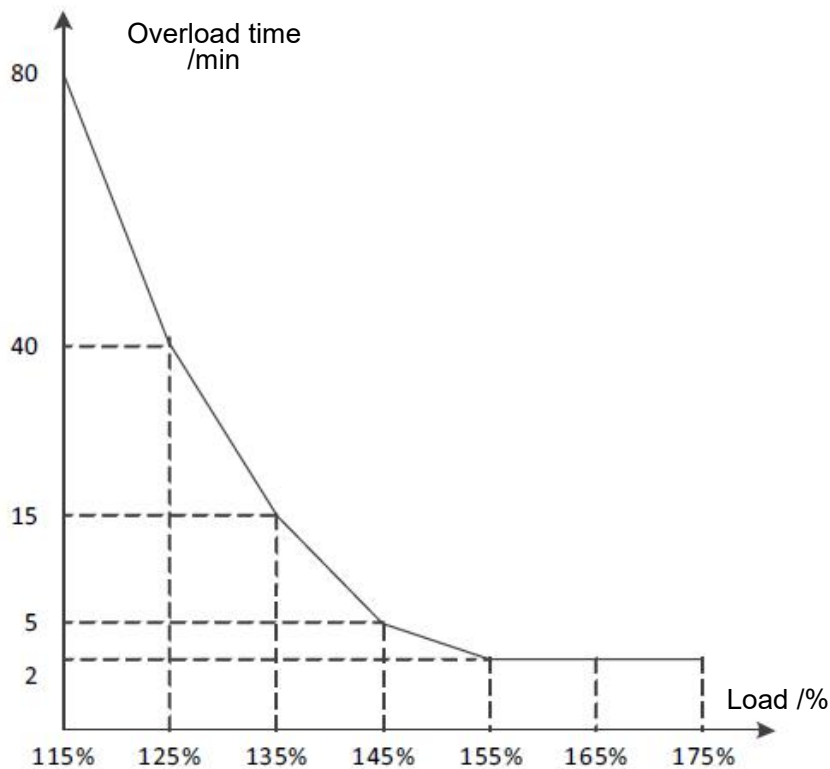

Figure 5 - 25 overload current vs. overload time curve

For example: if the motor is required to run at 120 % of the motor current for 30 minutes to report overload, the default setting will be calculated first motor current IX overloaded for 30 minutes.

According to the motor overload graph, if the 30 - minute overload is within the current range of 125 % and 135 %, then it can be concluded that the 30 - minute overload motor current IX under the default setting is as follows:

$$(40-30) \div (125\%-I_x) = (40-15) \div (125\%-135\%)$$

The result shows that the motor current IX = 129 %, so it can be concluded that the motor needs to overload for 30 minutes at 120 % of the motor current, and the motor overload protection gain:

$$F9-01=120\% \div I_x=120\% \div 129\%=0.93$$

Note: the user needs to set the value of F9 - 01 correctly according to the actual overload capacity of the motor. If the parameter setting is too large, it is likely to cause overheating damage to the motor and the frequency inverter does not give an alarm in time to protect it!

F9 - 02 motor overload warning coefficient	50%~100%[80%]
--	---------------

This function is used to give an early warning signal to the control system through do before motor overload fault protection. This early warning coefficient is used to determine how much early warning is to be given before motor overload protection. The higher the value, the smaller the advance warning amount

When the frequency inverter output current accumulation is greater than the product of the overload inverse time limit curve and F9 - 02, the multi-function digital word DO of the frequency inverter outputs the "motor overload pre-alarm" on signal

F9 - 03 over voltage stall gain	0~100 [30]
F9 - 04 stall over voltage point	200.0V~2000.0V [760.0%]

F9 - 03 = 0: over voltage stall protection function is invalid.

F9 - 03 non - 0: over voltage stall protection function is valid.

During the speed reduction of the frequency inverter, due to the influence of the load inertia, the actual decrease of the motor speed may be lower than the decrease rate of the output frequency. At this time, the motor will feed back electric energy to the frequency inverter, causing the voltage of the DC bus of the frequency inverter to rise. If no measures are taken, an over voltage fault will occur.

The over-voltage stall protection function detects the bus voltage during the deceleration operation of the inverter, and compares with the stall over-voltage point F9 - 04. If the stall voltage is exceeded, the output frequency of the inverter stops falling. When the bus voltage is lower than the stall over-voltage point, the deceleration operation is implemented again.

F9 - 03 the greater the over voltage stall gain setting, the stronger the ability to suppress over voltage. However, on the premise that no over voltage occurs, the smaller the benefit increase setting is, the better.

For loads with small inertia, the over-pressure stall gain should be small; otherwise the system's dynamic response will slow down.

For large inertia loads, this value should be large; otherwise, the suppression effect is not good and over voltage faults may occur.

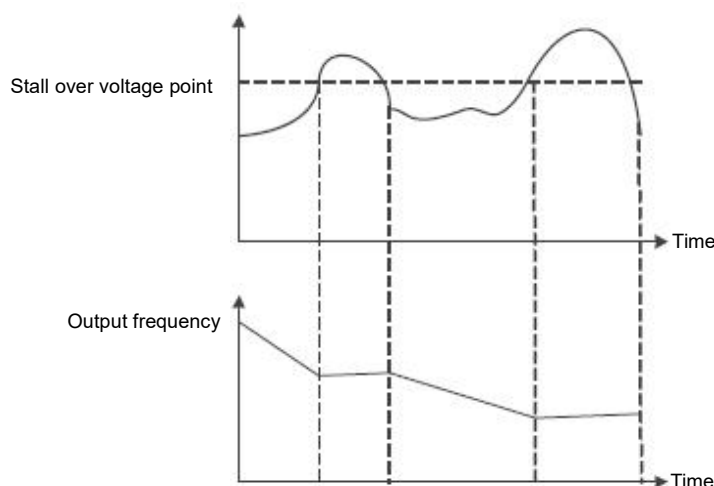

Figure 5 - 26 over voltage stall function

F9 - 05 over loss rate gain	0~100 [20]
-----------------------------	------------

F9 - 06 stall flow point	100%~200% [150%]
--------------------------	------------------

Over current speed: when the frequency inverter output current reaches the set over current stall protection current (F9 - 06), the frequency inverter will reduce the output frequency when accelerating operation; Reduce the output frequency during constant speed operation; During deceleration operation, the speed of descent is slowed down until the current is less than the over current stall protection current (F9 - 06) before the operating frequency returns to normal.

Over current stall protection current: select the current protection point with over current speed function. The frequency inverter starts to perform over-current stall protection function beyond this parameter value. This value is the percentage of the rated current of the motor.

Over - loss speed gain: used to adjust the frequency inverter's ability to suppress over-current during acceleration and deceleration. The greater the value, the stronger the ability to suppress over current on the premise of no over current, and the smaller the gain setting, the better.

For loads with small inertia, the over-loss rate gain should be small; otherwise the system's dynamic response will slow down.

For loads with large inertia, this value should be large; otherwise, the suppression effect is not good and over current faults may occur.

When the inertia is very small, it is recommended to set the over current suppression gain to less than 20. The over-run speed gain is set to 0, the over-run speed function will be cancelled.

F9 - 07 selection of short circuit protection from power on to ground	0~1 [1]
---	---------

0: power-on short circuit test to ground is invalid.

1: power-on short circuit detection to ground is valid.

This function is valid, and then the uvw end of the frequency inverter will have a voltage output for a period of time after power - up, which will last for 500 Ms.

F9 - 09 number of automatic resets for faults	0~20 [0]
---	----------

The automatic fault reset function can automatically reset faults in operation according to the set number of times and interval F9 - 11. When the number of automatic resets is set to 0, automatic resets are prohibited and fault protection is performed immediately.

F9 - 10 fault DO action selection during automatic fault reset	0~1 [0]
--	---------

0: during the fault, the fault DO does not output.

1: fault DO output during fault.

F9 - 11 fault DO action selection during automatic fault reset	0.1s~100.0s[1.0s]
--	-------------------

F9 - 12 input phase missing \ contactor suction protection selection	00~11[11]
--	-----------

Bit: input phase missing protection

0: input phase missing does not fail.

1: the panel displays IPL if the input is out of phase.

10 bits: contactor suction protection

0: contactor failure when not suction.

1: failure when contactor does not suck, panel shows ref

F9 - 13 selection of out-of-phase protection for output	0~1 [1]
---	---------

0: no fault protection when the output is out of phase.

1: when the output is out of phase, fault protection and OPL are displayed on the panel.

F9 - 14 fault protection action selection 1	00000~22222 [00000]
---	---------------------

Bits: motor overload fault OL2

- 10 bits: input phase failure IPL.
- 100 bits: output phase-missing fault OPL.
- 1000 bits: external failure ETF.
- 10,000 bits: communication failure COF.
- 0: free parking. Once OL2 fails, stop the parking freely.
- 1: stop the machine according to the set stop method.
- 2: continue running.

F9 - 15 fault protection action selection 2	00000~22222 [00000]
---	---------------------

- Bit:
- 10 bits: EEPROM fault EPF.
 - 100 bits: reserved.
 - 1000 bits: reserved.
 - 10,000 bits: accumulated time reaches RTAF.
 - 0: free parking.
 - 1: stop the machine according to the set stop method.
 - 2: continue running.

F9 - 16 fault protection action selection 3	00000~22222 [00000]
---	---------------------

- Bit: custom fault uEF1.
- 10 bits: user-defined fault uEF2.
 - 100 bits: power-on time reaches faulty utF.
 - 1000 bits: load shedding fault LLf.
 - 10,000 bits: PID feedback lost fault PIDF.
 - 0: free parking.
 - 1: stop the machine according to the set stop method.
 - 2: continue running.

F9 - 17 fault protection action selection 4	00000~22222 [00000]
---	---------------------

- Bit: failure DEU due to excessive speed deviation.
- 10 digits: motor over speed OSF.
 - 100 bits: initial position error POF.
 - 1000 bits: load shedding fault LLF.
 - 10,000 bits: reserved.
 - 0: free parking.
 - 1: stop the machine according to the set stop method.
 - 2: continue running.

F9 - 21 continue operating frequency selection in case of failure	0~4 [0]
---	---------

- 0: run at current operating frequency
- 1: run at the set frequency
- 2: run at the upper limit frequency
- 3: the following limited frequency operation
- 4: run at abnormal standby frequency.

If a fault occurs during the operation of the frequency inverter, and the processing method of the fault is set to continue running, F9 - 21 will be used for confirmation run at a fixed frequency.

When selecting an abnormal standby frequency to run, the value set by F9 - 22 is a percentage of the maximum frequency.

F9 - 22 abnormal standby frequency	0.0 % - 100.0 % (maximum frequency) [100.0 %]
------------------------------------	---

F9 - 23 motor sensor type	0~2 【0】
---------------------------	---------

0: no temperature sensor.
 1:PT100.
 2:PT1000.

F9 - 24 motor overheating threshold	0℃~200℃ 【110】
-------------------------------------	---------------

F9 - 25 motor overheating warning threshold	0℃~200℃ 【90】
---	--------------

The sensor type must be set correctly for using, and the motor temperature value is displayed in U0 - 34.

When the motor temperature (U0 - 34) exceeds the motor overheat protection threshold F9 - 24, the frequency inverter fails to give an alarm.

When the motor temperature (u0 - 34) exceeds the motor overheat warning threshold, the multi-function digital output "motor overheat warning" of the frequency inverter will output a signal.

F9 - 26 off-load protection options	0~1 【0】
-------------------------------------	---------

0: invalid.
 1: valid.

F9 - 27 load shedding test level	0.0 % ~ 100.0 % (rated current of motor) 【10.0%】
----------------------------------	---

F9 - 28 off-load test time	0.0s~60.0s 【1.0s】
----------------------------	-------------------

F9 - 26 off-load protection function is valid, when the frequency inverter output current is less than the off-load detection level F9 - 27 and the duration is greater than the off-load detection time F9 - 28, and the frequency inverter output frequency is automatically reduced to 7 % of the rated frequency. During the period of off-load protection, if the load recovers, the frequency inverter will automatically resume operating at the set frequency.

F9 - 30 over-speed detection value	0.0 % - 50.0 % (maximum frequency) 【20.0 %】
------------------------------------	---

F9 - 31 over-speed detection time	0.0s~60.0s 【1.0s】
-----------------------------------	-------------------

When the frequency inverter detects that the actual rotational speed of the motor exceeds the maximum frequency, the exceeding value is greater than the over-speed detection value F9 - 30, and the duration is greater than the over-speed detection time F9 - 31, the frequency inverter fails to alarm OSF, and processes it according to the failure protection operation mode.

If the over-speed detection time F9 - 31 is 0.0s, the over-speed fault detection will be cancelled.

F9 - 32 speed deviation too large detection value	0.0 % - 50.0 % (maximum frequency) [20.0 %]
---	---

F9 - 33 excessive speed deviation detection time	0.0s~60.0s 【5.0s】
--	-------------------

When the frequency inverter detects that the actual rotation speed of the motor deviates from the set frequency, the deviation is greater than the measured value F9 - 32 of excessive speed deviation, and the duration is greater than the detected time F9 - 33 of excessive speed deviation, the frequency inverter fails to give an alarm DEU and processes it according to the failure protection action mode.

When the detection time for excessive speed deviation is 0.0s, the fault detection for excessive speed deviation will be cancelled.

FA Group process control PID function

PID control is a common method of process control. By performing proportional, integral and differential operations on the difference between the feedback signal of the controlled quantity and the target signal, and adjusting the output frequency of the frequency inverter, a closed loop system is formed to stabilize the controlled quantity at the target value.

Suitable for flow control, pressure control, temperature control and other process control occasions. Figure 5 - 27 is the control principle block diagram of process PID.

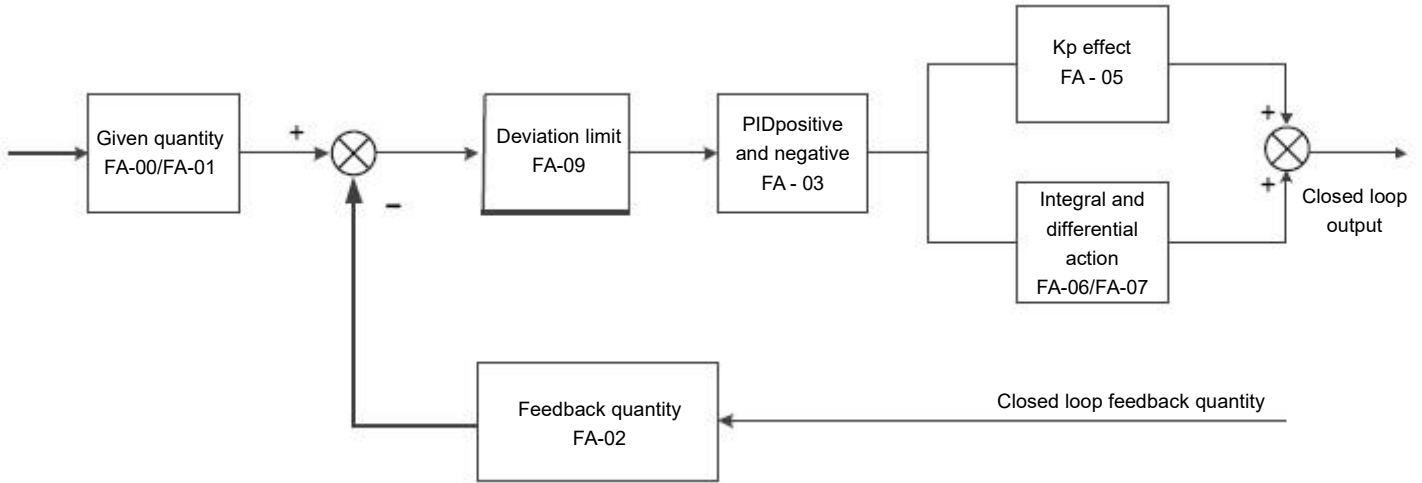

Figure 5 - 27 process PID principle block diagram

FA - 00 PID given channel selection	0~6 【0】
-------------------------------------	----------------

0: FA - 01 setting.

1: AI1.

2: AI2

3: AI3

4: X5 pulse setting

5: communication settings.

6: multi-speed setting.

7: FA-01 setting (up/down can be changed)

FA - 01 PID digital setting	0.0%~100.0% 【50.0%】
-----------------------------	----------------------------

The setting target amount of the process PID is a relative value, and the setting range is 0.0 % - 100.0 %. Similarly, the feedback quantity of PID is also a relative quantity, and the function of PID is to make these two relative quantities the same.

FA - 02 PID feedback channel selection	0~8 【0】
--	----------------

0: AI1。

1: AI2

2: AI3

3: AI1-AI2

4: X5 pulse quantity

5: communication.

6: AI1+AI2

7: MAX (|AI1|, |AI2|)

8: MIN (|AI1|, |AI2|)

The feedback amount of the process PID is also a relative value, and the setting range is 0.0 % - 100.0 %.

FA - 03 PID direction of action	0~1 [0]
---------------------------------	---------

0: positive effect

When the feedback signal of PID is less than a given amount, the output frequency of the frequency inverter increases. Such as tension control occasions for winding.

1: reaction.

When the feedback signal of PID is less than a given amount, the output frequency of the frequency inverter will be decreased. Such as tension control occasions for unwinding.

This function is affected by the reversal of the direction of action of the multi-function terminal PID (function 35), which requires attention in use.

FA - 04 PID gives feedback range	10~65535 【1000】
----------------------------------	-----------------

PID given feedback range is dimensionless unit, used for PID given display U0 - 15 and PID feedback display u0 - 16.

The relative value of the given feedback of PID is 100.0 %, corresponding to the given feedback range FA - 04. For example, if FA - 04 is set to 2000, when the PID is given 100.0 %, the PID given display u0 - 15 is 2000.

FA-05 proportional gain Kp1	0.0~100.0 [20.0]
FA-06 integration time Ti1	0.01s~10.00s [2.00S]
FA-07 differential time Td1	0.00~10.000 [0.000s]

Proportional gain Kp1:

Determining the adjusting intensity of the whole PID regulator, the greater kp1, the greater the adjusting intensity. The parameter is 100. 0 indicates when PID is inverted when the deviation between the feed quantity and the given quantity is 100.0 %, the regulating amplitude of the PID regulator to the output frequency command is the maximum frequency.

Integration time Ti1:

Determines the strength of integral adjustment of PID regulator. The shorter the integration time, the greater the adjustment intensity the integration time refers to when the deviation between the PID feedback quantity and the given quantity is 100.0 %, the integral regulator continuously adjusts after this time, and the adjustment quantity reaches the maximum frequency.

Differential time Td1:

Determines the strength of the PID regulator to adjust the deviation rate of change. The longer the differentiation time, the greater the adjustment intensity. Differential time it means that when the feedback amount changes by 100.0 % within this time, the adjustment amount of the differential regulator is the maximum frequency.

FA - 08 PID inversion cutoff frequency limit	0. 00 ~ maximum frequency [0.00 Hz]
--	-------------------------------------

In some cases, only when the output frequency of the PID is negative (i.e. the frequency inverter inverts), can the PID control the given amount and the feedback amount to the same state, but too high an inversion frequency is not allowed in some cases, and FA - 08 is used to determine the upper limit of the inversion frequency.

FA - 09 PID deviation limit	0. 0%~100.0% [0.0%]
-----------------------------	---------------------

When the deviation between the given PID quantity and the feedback quantity is less than FA - 09, the PID stops the adjusting action, and the output frequency is stable when the deviation between the given quantity and the feedback is small.

FA - 10 PID differential clipping	0.00%~100.00% 【0.10%】
-----------------------------------	-----------------------

In PID regulator, the function of differentiation is relatively sensitive, which easily causes system oscillation. The function of PID differentiation is limited to a small range.

FA - 11 PID given change time	0.00s~650.00s 【0.00s】
-------------------------------	-----------------------

The given change time of PID refers to the time required for the given value of PID to change from 0.0 % to 100.0 %.

When the PID given value changes, the PID given value changes linearly according to the given change time, thus reducing the occurrence of mutation in the given value adverse impact on the system

FA- 12 PID feedback filtering time	0.00s~60.00s 【0.00s】
FA - 13 PID output filtering time	0.00s~60.00s 【0.00s】

FA- 12 is used to filter the PID feedback quantity. The filter is helpful to reduce the influence of the feedback quantity being interfered, but it will bring about a decrease in the response performance of the process closed loop system.

FA- 13 is used to filter the PID output frequency. This filter will weaken the abrupt change of the frequency inverter output frequency, but it will also bring about a decrease in the response performance of the process closed loop system.

FA-15 Proportional gain kp2	0.0~100.0 【20.0】
FA-16 Integration time Ti2	0.01s~10.00s 【2.00s】
FA-17 Differential time Td2	0.00~10.000 【0.000s】

In some applications, a group of PID parameters cannot meet the requirements of the whole operation process, and different PID parameters need to be adopted in different situations.

The above function code is used for switching the two groups of PID parameters. The setting mode of regulator parameters FA - 15 ~ FA - 17 is similar to parameters FA - 05 ~ FA - 07.

FA - 18 PID parameter switching conditions	0~3 【0】
--	---------

0: do not switch, only use the first group of PID (FA - 05 ~ FA - 07) parameters.

1: switch through X terminal. Multi-function X terminal function selection to be set to 43 (PID parameter switching terminal), when the terminal is invalid, select the parameter

Group 1 (FA - 05 ~ FA - 07), select parameter group 2 (FA - 15 ~ FA - 17) when the terminal is active

2: switch automatically according to deviation.

Given the absolute value of deviation from feedback is less than PID parameter switching deviation 1 (FA - 19), PID parameter selection parameter group 1.

Given that the absolute value of the deviation from the feedback is greater than PID switching deviation 2 (FA - 20), PID parameter selection selects parameter group 2.

Given that the deviation from feedback is between switching deviation 1 and switching deviation 2, the PID parameters are linear interpolation values of two sets of PID parameters, as shown in figure 5 - 28.

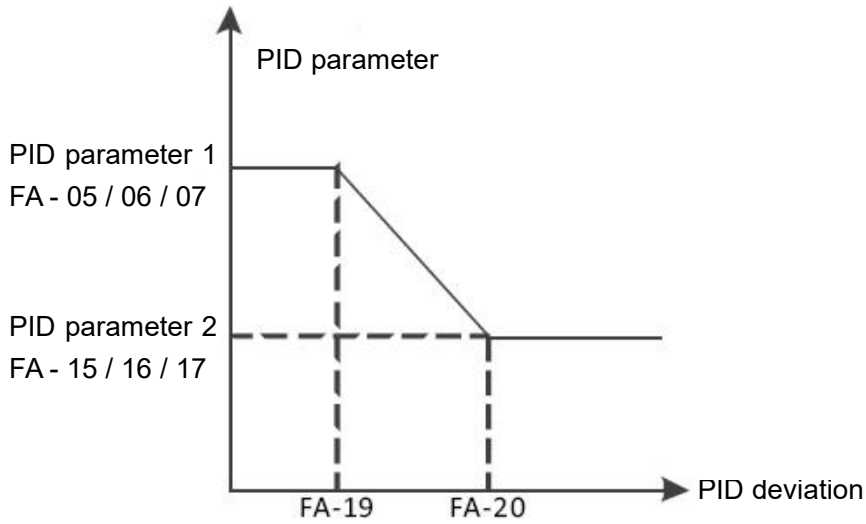

Figure 5 - 28 schematic diagram of PID switching based on deviation

3: automatically switch according to operating frequency.

When the absolute value of the output frequency is equal to 0, the PID parameter selects parameter group 1.

When the absolute value of the output frequency is equal to the maximum frequency (F0 - 16), PID parameter selection selects parameter group 2.

When the output frequency is between 0 Hz and the maximum frequency, the PID parameters are linear interpolation values of two groups of PID parameters, as shown in figure 5 - 29.

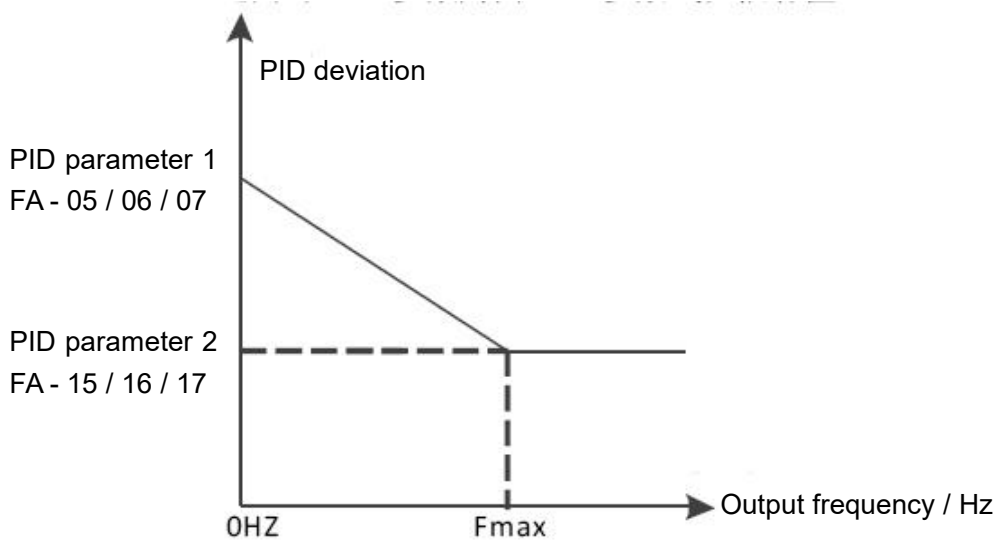

Figure 5 - 29 schematic diagram of PID switching according to operating frequency

FA - 19 PID parameter switching deviation 1	0.0%~FA-20 【20.0%】
FA - 20 PID parameter switching deviation 2	FA-19~100.0% 【80.0%】

FA - 21 PID initial value	0.0%~100.0% 【0.0%】
FA - 22 PID initial value holding time	0.00s~650.00s 【0.00s】

When the frequency inverter is started, the PID output is fixed to the PID initial value FA - 21, and after the PID initial value keeping time FA - 22 is continued, PID began the closed loop adjustment operation. Figure 5 - 30 is a functional diagram of the initial PID value.

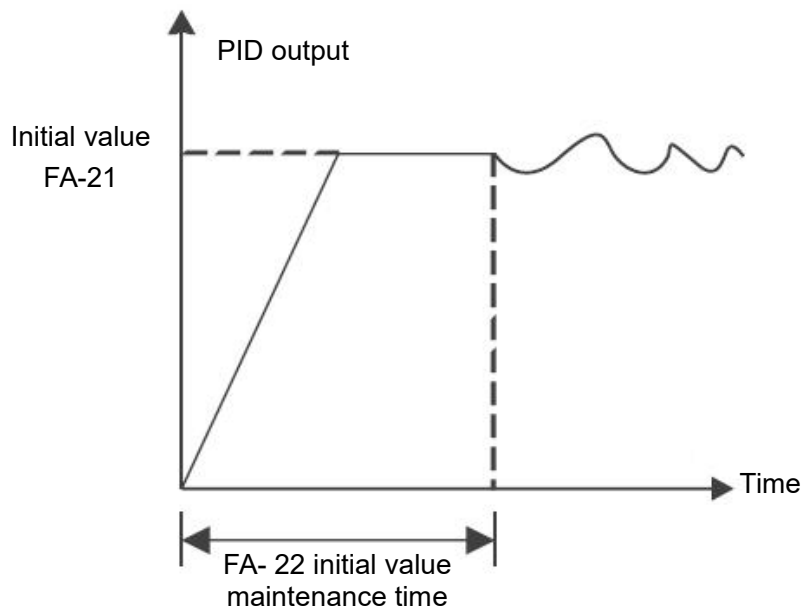

Figure 5 - 30 functional diagram of PID initial value

FA - 23 twice output deviation positive maximum	0.00%~100.00% 【1.00%】
FA - 24 twice output deviation reverse maximum	0.00%~100.00% 【1.00%】

This function is used to limit the difference between the two beats (2 ms / beat) of the PID output so as to prevent the PID output from changing too fast and stabilize the operation of the frequency inverter.

FA - 23 and FA - 24 respectively correspond to the maximum absolute value of the output deviation in forward and reverse directions.

FA - 25 PID integral attribute	00~11 【00】
--------------------------------	------------

Bit: PID integral separation

0: invalid.

No matter what kind of state, Ti integral of PID plays a role.

1: valid.

When the multifunctional digital X - terminal integral pause (function 22) is valid, the integral PID integral of the PID stops the operation, and at this time the PID only has proportional and differential effects.

Ten digits: whether to stop integrating after outputting to the limit value.

0: continue to score.

When the PID outputs to the upper limit frequency or the lower limit frequency, the integral calculation will continue.

1: stop points.

When the PID is output to the upper limit frequency or the lower limit frequency, the calculation of the PID integral will stop at this time, which may help to reduce the overshoot of the PID.

FA- 26 PID feedback loss detection value	0.1%~100.0% 【0.0%】
FA - 27 PID feedback loss detection time	0.0s~20.0s 【0.0s】

When FA - 26 = 0.0, PID does not judge that feedback is lost;

When FA - 26 is not 0, when the PID feedback amount is less than the feedback loss detection value FA - 26 and the duration exceeds the PID feedback loss detection time FA - 27, the frequency inverter alarms the fault pidf and processes it according to the selected fault processing method.

FA - 28 PID shutdown operation	0~1 【0】
--------------------------------	---------

0: stop without calculation.

1: stop operation.

Use to select whether the PID will continue to operate under the shutdown state of the PID. In general applications, PID should the operation should be stopped.

FA - 29 pressure sleep option	0~1 【0】
-------------------------------	---------

0: the frequency inverter sleeps and wakes up according to the frequency node according to the functions of F8 - 14 ~ F8 - 17.

1: the frequency inverter sleeps and wakes up according to the pressure node according to the functions of FA - 30 ~ FA - 33.

FA - 30 wake-up pressure percentage	0.0~100.0% 【80.0%】
-------------------------------------	--------------------

FA - 31 wake-up pressure delay time	0~6000.0 【1.0】
-------------------------------------	----------------

Wake up pressure percent = (wake up pressure / target pressure) X 100 %.

When the feedback pressure is less than the wake-up pressure, it will enter the wake-up state after FA - 31 times.

FA - 32 sleep pressure percentage	50.0~1000.0% 【80.0%】
-----------------------------------	----------------------

FA - 33 sleep pressure delay time	0~6000.0 【60.0】
-----------------------------------	-----------------

Sleep pressure percentage = (sleep pressure / target pressure) X 100 %.

When the feedback pressure is greater than the sleep pressure, it will enter the sleep state.

Note: during sleep, the operation indicator on the control panel flashes for 1s cycle.

FB Group 2 motor parameters

HV610 can switch operation between two motors. The two motors can respectively set motor nameplate parameters and can respectively enter Line motor parameter tuning, VF control or vector control can be selected separately, encoder related parameters can be set separately, and parameters related to VF control or vector control performance can be set separately.

The Fb group function code corresponds to all parameters of the motor 2 and FB group. Its content definition and usage method are consistent with those of the first motor. This will not be repeated here. The user can refer to the description of the relevant parameters of the first motor. The specific FB - 00 ~ FB - 37 refers to f1 - 00 ~ f1 - 37 group parameters, and FB - 38 ~ FB - 55 refers to F2 - 00 ~ F2 - 17 parameters.

FB - 61 2nd motor control mode	0~2 【0】
--------------------------------	---------

When the motor is selected as the second motor, the control mode takes effect, and the definitions of 0 ~ 2 are the same as F0 - 01.

0: no PG open loop vector control

1: PG closed loop vector control

2: V/F

FB - 62 second motor acceleration and deceleration time selection	0~4 【0】
---	---------

0: the acceleration and deceleration time is the same as that of the first motor.

1: the first group of acceleration and deceleration time

- 2: acceleration and deceleration time of the second group
- 3: acceleration and deceleration time of the third group
- 4: the fourth group of acceleration and deceleration time

FB - 63 2nd motor torque boost	0.0 % ~ 30.0 % [model determination]
--------------------------------	--------------------------------------

Same as F3 - 01 torque boost function of the first motor.

FB - 64 second motor oscillation suppression gain	0 ~ 100 [model determination]
---	-------------------------------

Same as F3 - 11 oscillation suppression function of the first motor.

FC Group multi-segment instruction and simple PLC function

HV610 multi-segment instruction has more abundant functions than usual multi-segment speed. Besides realizing multi-segment speed function, it can also be used as a voltage source for VF separation and a given source for process PID. For this reason, the dimension of the multi-segment instruction is a relative value.

The simple PLC function is a multi-section speed generator. The frequency inverter automatically numbers the running frequency and direction according to the running time to meet the technological requirements. The function was previously completed by the PLC (programmable controller) and now depends on the frequency inverter. As shown in figure 5 - 31.

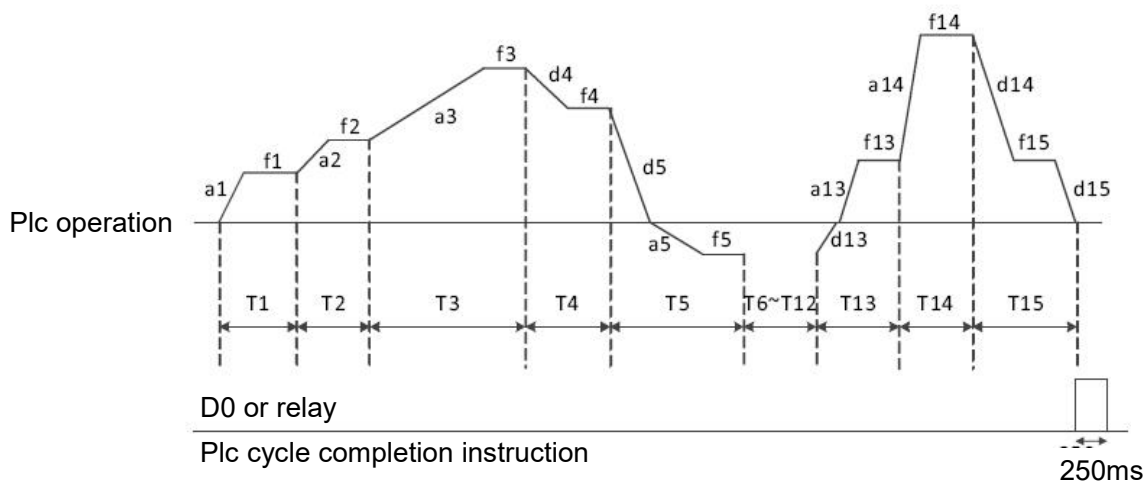

Figure 5 - 31 simple PLC operation diagram

In fig. 5 - 31, a1 ~ a15 / D1 ~ d15 are the acceleration and deceleration times of the stage where they are located, while f1 ~ f15 and t1 ~ t15 are the set frequencies and stage operation times of the stage where they are located.

FC-00	Multi - segment instruction 0	-100.0%~100.0% 【0.0%】
FC-01	Multi - segment instruction 1	-100.0%~100.0% 【0.0%】
FC-02	Multi - segment instruction 2	-100.0%~100.0% 【0.0%】

FC - 03 multi-segment instruction 3	-100.0%~100.0% 【0.0%】
FC - 04 multi-segment instruction 4	-100.0%~100.0% 【0.0%】
FC - 05 multi-segment instruction 5	-100.0%~100.0% 【0.0%】
FC - 06 multi-segment instruction 6	-100.0%~100.0% 【0.0%】
FC - 07 multi-segment instruction 7	-100.0%~100.0% 【0.0%】
FC - 08 multi-segment instruction 8	-100.0%~100.0% 【0.0%】
FC - 09 multi-segment instruction 9	-100.0%~100.0% 【0.0%】
FC - 10 multi-segment instruction 10	-100.0%~100.0% 【0.0%】
FC - 11 multi-segment instruction 11	-100.0%~100.0% 【0.0%】
FC - 12 multi-segment instruction 12	-100.0%~100.0% 【0.0%】
FC - 13 multi-segment instruction 13	-100.0%~100.0% 【0.0%】
FC - 14 multi-segment instruction 14	-100.0%~100.0% 【0.0%】
FC - 15 multi-segment instruction 15	-100.0%~100.0% 【0.0%】

Multi-segment instruction can be used in three situations: multi-segment speed as frequency source, simple PLC, voltage source as VF separation, and setting source of process PID.

In the three applications, the dimension of the multi-segment instruction is the relative value, ranging from -100.0 % to 100.0 %.

Which is the percentage of the relative maximum frequency when used as the frequency source.

When VF is used as a separate voltage source, it is a percentage of the rated voltage of the motor.

Given the relative value of PID, multi-segment instructions as the PID setting source do not require dimensional conversion.

The multi-segment instructions need to be switched and selected according to different States of the multi-function digital X terminal, please refer to F5 group for details relevant instructions.

FC - 16 simple PLC operation mode	1~2 【0】
-----------------------------------	---------

0: stop after single operation. As shown in figure 5 - 32, the frequency inverter stops automatically after completing one cycle, and it needs to be transported again to run.

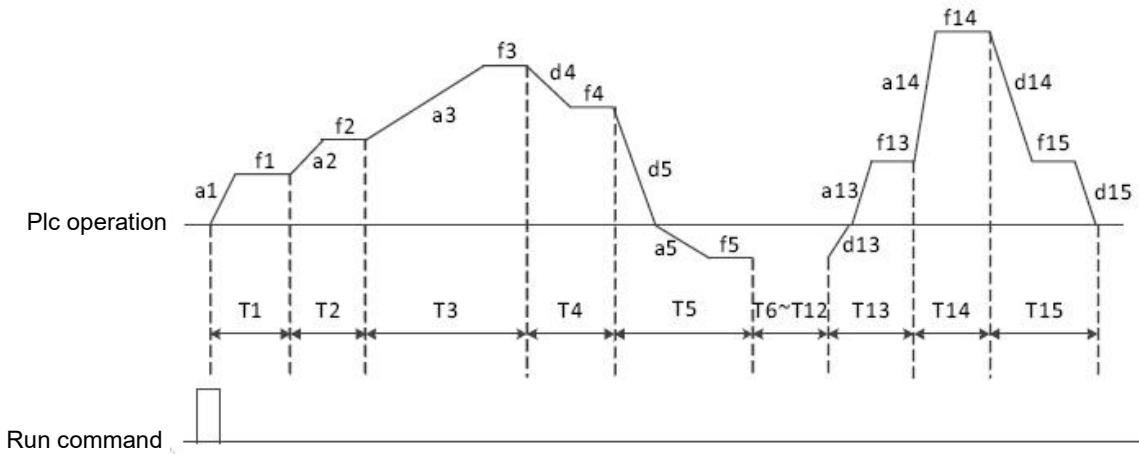

Figure 5 - 32 shutdown modes after single cycle

1: Maintain the final value at the end of a single run. As shown in figure 5 - 33, the frequency inverter automatically maintains the operating frequency of the last section after completing one cycle.

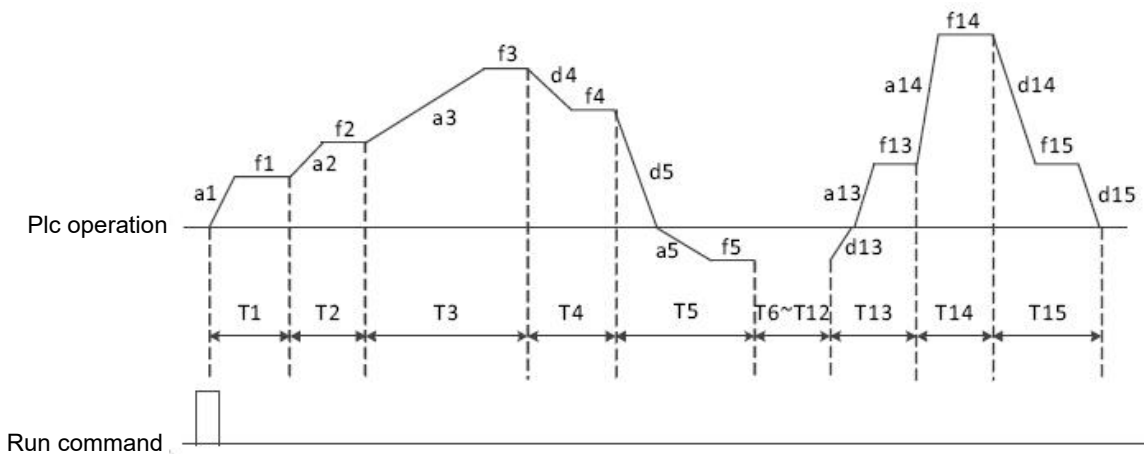

Figure 5 - 33 PLC maintains final value after single cycle

2: Keep running in a cycle.

After the frequency inverter completes one cycle, it will automatically start the next cycle until there is a stop command.

FC - 17 Simple PLC memory selection	00~11 【00】
-------------------------------------	------------

Bit: power failure memory option.

0: no memory when power fails.

When power is lost, the PLC operation state will not be memorized. When power is turned on, the PLC will start to run again from the first stage.

1: power failure memory.

When power is lost, the PLC operation status, including operation phase and frequency, and the time that has already been run, will be memorized. Continue to run from the memory stage after power - up.

Ten digits: stop memory option.

0: stop the machine and do not remember.

Each start-up starts from the first stage.

1: stop memory.

PLC shutdown memory is to record the previous PLC operation phase and frequency during shutdown, and continue to operate from the memory stage during the next operation.

FC - 18 Simple PLC section 0 operation time	0.0s(h)~6500.0s(h) 【0.0s(h)】
FC - 19 Simple PLC section 0 acceleration and deceleration time	0~3 【0】
FC - 20 Simple PLC first run time	0.0s(h)~6500.0s(h) 【0.0s(h)】
FC - 21 Simple PLC first acceleration and deceleration time	0~3 【0】
FC - 22 Simple PLC section 2 operation time	0.0s(h)~6500.0s(h) 【0.0s(h)】
FC - 23 Simple PLC second acceleration and deceleration time	0~3 【0】
FC - 24 Simple PLC section 3 operation time	0.0s(h)~6500.0s(h) 【0.0s(h)】
FC - 25 Simple PLC section 3 acceleration and deceleration time	0~3 【0】
FC - 26 Simple PLC section 4 operation time	0.0s(h)~6500.0s(h) 【0.0s(h)】
FC - 27 Simple PLC section 4 acceleration and deceleration time	0~3 【0】
FC - 28 Simple PLC section 5 operation time	0.0s(h)~6500.0s(h) 【0.0s(h)】
FC - 29 Simple PLC 5 acceleration and deceleration time	0~3 【0】
FC - 30 Simple PLC section 6 operation time	0.0s(h)~6500.0s(h) 【0.0s(h)】
FC - 31 Simple PLC section 6 acceleration and deceleration time	0~3 【0】
FC - 32 Simple PLC section 7 operation time	0.0s(h)~6500.0s(h) 【0.0s(h)】
FC - 33 Simple PLC section 7 acceleration and deceleration time	0~3 【0】
FC - 34 Simple PLC section 8 operation time	0.0s(h)~6500.0s(h) 【0.0s(h)】
FC - 35 Simple PLC section 8 acceleration and deceleration time	0~3 【0】
FC - 36 Simple PLC section 9 operation time	0.0s(h)~6500.0s(h) 【0.0s(h)】
FC - 37 Simple PLC section 9 acceleration and deceleration time	0~3 【0】

FC - 38 Simple PLC section 10 operation time	0.0s(h)~6500.0s(h) 【0.0s(h)】
FC - 39 Simple PLC 10th acceleration and deceleration time	0~3 【0】
FC - 40 Simple PLC section 11 operating time	0.0s(h)~6500.0s(h) 【0.0s(h)】
FC - 41 Simple PLC section 11 acceleration and deceleration time	0~3 【0】
FC - 42 Simple PLC section 12 operation time	0.0s(h)~6500.0s(h) 【0.0s(h)】
FC - 43 Simple PLC section 12 acceleration and deceleration time	0~3 【0】
FC - 44 Simple PLC section 13 operating time	0.0s(h)~6500.0s(h) 【0.0s(h)】
FC - 45 Simple PLC section 13 acceleration and deceleration time	0~3 【0】
FC - 46 Simple PLC section 14 operating time	0.0s(h)~6500.0s(h) 【0.0s(h)】
FC - 47 Simple PLC section 14 acceleration and deceleration time	0~3 【0】
FC - 48 Simple PLC section 15 operating time	0.0s(h)~6500.0s(h) 【0.0s(h)】
FC - 49 Simple PLC section 15 acceleration and deceleration time	0~3 【0】

FC - 50 Simple PLC running time unit	0~1 【0】
--------------------------------------	---------

0: S (seconds)

1: h (hours)

FC - 51 multi-segment instruction 0 given mode	0~6 【0】
--	---------

0: Given function code FC - 00

1: AI1

2: AI2

3: AI3

4: X5 pulse input.

5: PID.

6: Given the preset frequency (F0 - 09), up / down can be modified.

FD Group communication parameters

Please refer to appendix a: description of communication parameters of FD group.

FE Group user-defined function code

This group function code is a user-defined parameter group.

The user can select the required parameters from all HV610 function codes and summarize them to the Fe group as user-customized parameters.

Number to facilitate viewing and changing operations The Fe group provides up to 30 user-defined parameters, and the displayed value of the Fe group parameter is f 0.00, which indicates the user function code is empty.

When entering the user-defined parameter mode, the display function codes are defined by FE-00~FE-31. The order is the same as that of the FE group function codes. If F0 - 00, it will be skipped.

FF Group control optimization parameters

FF - 04	cbc current limiting enable	0~1 【0】
---------	-----------------------------	---------

0: not enabled.

1: enabling wave-by-wave current limiting.

By enabling the wave-by-wave current limiting function, the over-current fault of the frequency inverter can be minimized and the frequency inverter can be guaranteed to run uninterruptedly.

FF – 06	Uder voltage point setting	60%~140% 【100.0%】
---------	----------------------------	-------------------

Voltage value of frequency inverter under voltage fault LV

FF – 09	over voltage point setting	200.0V~2200.0V 【820.0V】
---------	----------------------------	-------------------------

Note: the factory value is also the upper limit value of the internal over voltage protection of the frequency inverter. This parameter setting will only take effect if the FF - 09 setting value is less than the factory value. If it is higher than the factory value, the factory value shall prevail.

E0 Group fault record

E0-00	First failure type	0~99 【0】
E0-01	Second failure type	0~99 【0】
E0-02	Third (most recent) fault type	0~99 【0】
E0-03	Frequency at third failure	0.00~500.00 【0.00HZ】

E0 – 04	Current at third fault	0.00~500.00 【0.00A】
E0 – 05	Bus voltage at the third fault	0.0~2000.0 【0.0V】
E0 – 08	Frequency inverter status at third failure	0~65535 【0】
E0 – 09	Power-on time for third failure	0~65535 【0】
E0 – 10	Run time at third failure	0~65535 【0】
E0 – 13	Frequency at second failure	0.00~500.00 【0.00HZ】
E0 – 14	Current at second failure	0.00~500.00 【0.00A】
E0 – 15	Bus voltage at second failure	0.0~2000.0 【0.0V】
E0 – 18	Frequency inverter status at second failure	0~65535 【0】
E0 – 19	Power-on time for second failure	0~65535 【0】
E0 – 20	Run time at second failure	0~65535 【0】
E0 – 23	Frequency at first failure	0.00~500.00 【0.00HZ】
E0 – 24	Current at first failure	0.00~500.00 【0.00A】
E0 – 25	Bus voltage at first failure	0.0~2000.0 【0.0V】
E0 – 28	Frequency inverter status at first failure	0~65535 【0】
E0 – 29	Power-on time for first failure	0~65535 【0】
E0 – 30	Run time at first failure	0~65535 【0】

P2 Group AIAO correction

P2 – 00	A I1 measured voltage 1	-10.000V~10.000V 【2.000V】
P2 – 01	A I1 shows voltage 1	-10.000V~10.000V 【2.000V】
P2 – 02	A I1 measured voltage 2	-10.000V~10.000V 【8.000V】
P2 - 03	AI1 shows voltage 2	-10.000V~10.000V 【8.000V】
P2 - 04	AI2 measured voltage 1	-10.000V~10.000V 【2.000V】
P2 – 05	AI2 shows voltage 1	-10.000V~10.000V 【2.000V】
P2 – 06	AI2 measured voltage 2	-10.000V~10.000V 【8.000V】
P2 – 07	AI2 shows voltage 2	-10.000V~10.000V 【8.000V】
P2 – 08	AI3 measured voltage 1	-10.000V~10.000V 【2.000V】
P2 – 09	AI3 shows voltage 1	-10.000V~10.000V 【2.000V】
P2 – 10	AI3 measured voltage 2	-10.000V~10.000V 【8.000V】
P2 – 11	AI3 shows voltage 2	-10.000V~10.000V 【8.000V】

The set of function codes is used to correct the analog quantity input AI to eliminate the influence of zero offset and gain at the AI input.

The set of functional parameters has been corrected at the factory. When the factory value is restored, it will be restored to the factory corrected value. Generally, no correction is required at the application site.

Measured voltage refers to the actual voltage measured by measuring instruments such as multimeter.

Display voltage refers to the voltage display value sampled by the frequency converter. See u0 group ai pre-correction voltages (U0 - 21, U0 - 22, U0 - 23) for display.

During correction, two voltage values are input to each AI input port, and the values measured by the multimeter and the values read by the U0 group are input into the above function codes accurately, then the frequency converter will automatically correct the zero offset and gain of AI.

For the situation where the voltage given does not match the actual sample voltage of the frequency converter, a field correction method can be adopted so that the sampling value of the frequency convert is consistent with the expected given value.

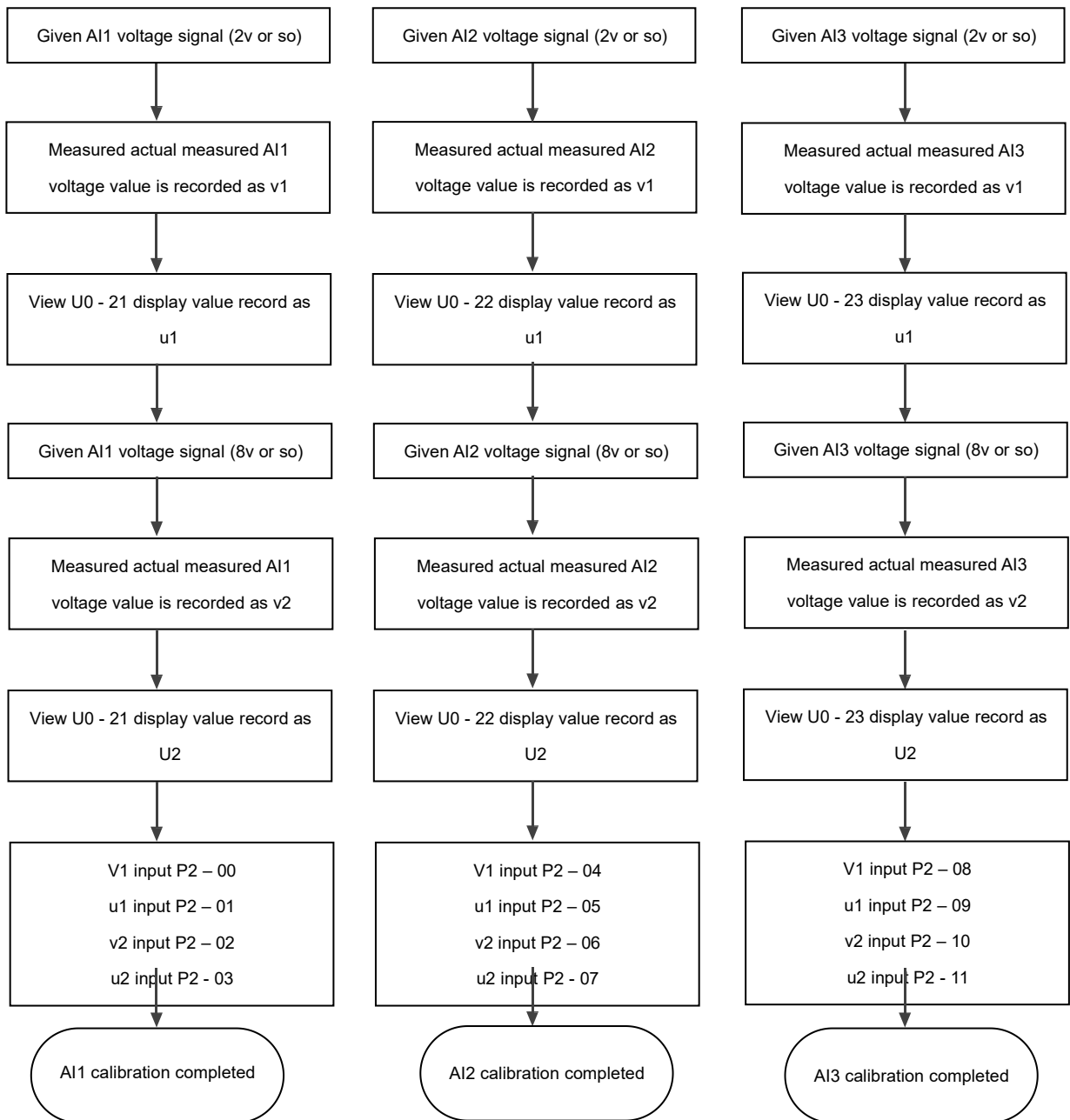

Figure 5 - 34 AI calibration method diagram

U0 Group monitoring parameter group

The U0 parameter group is used to monitor the operation status information of the frequency inverter. Customers can check it through the panel to facilitate on-site commissioning. They can also read the parameter group values through communication for monitoring by the upper computer. The communication address is 0x7000 ~ 0x7044.

U0-00	Running frequency	Indication range	0.00: 500.00Hz
U0-01	Set frequency		

Display the absolute values of the theoretical operating frequency and the set frequency of the frequency inverter. See U0 - 19 for actual output frequency of frequency inverter.

U0-02	Busbar voltage	Indication range	0.0V~3000.0V
-------	----------------	------------------	--------------

Display the inverter bus voltage value.

U0-03	Output voltage	Indication range	0V~1140V
-------	----------------	------------------	----------

Display the output voltage value of the frequency inverter during operation.

U0-04	Output current	Indication range	0.00A~655.35A (frequency inverter power ≤ 55kw) (frequency inverter power > 55kw)
-------	----------------	------------------	---

Display the output current value of the frequency inverter during operation.

U0-05	Output power	Indication range	0~32767
-------	--------------	------------------	---------

Display the output power value of the frequency inverter during operation.

U0-06	Output torque	Indication range	-200.0% - 200.0%
-------	---------------	------------------	------------------

Display the output torque value of the frequency inverter during operation.

U0-07	X terminal input status	Indication range	0~32767
-------	-------------------------	------------------	---------

Display the current X terminal input status value. After being converted into binary data, each bit corresponds to X input signal, a value of 1 indicates that the input is a high level signal, and a value of 0 indicates that the input is a low level signal. The correspondence between each bit and the input terminal is as follows:

Bit0	Bit1	Bit2	Bit3
X1	X2	X3	X4
Bit4	Bit5	Bit6	
X5	X6	X7	

U0-08	Do output state	Indication range	0~1023
-------	-----------------	------------------	--------

Display the current DO terminal output status value. After being converted into binary data, each bit corresponds to a DO signal, indicating the output high level for 1 and the output low level for 0. The correspondence between each bit and the output terminal is as follows:

	Bit1		Bit3
	Relay 1		DO1
Bit4			
DO2			

U0-10	AI2 voltage (v) / current (mA)	Indication range	0.00V~10.57V 0.00mA~20.00mA
-------	------------------------------------	------------------	--------------------------------

U0-14	Load speed display	Indication range	0~65535
U0-15	PID setting	Indication range	0~65535
U0-16	PID feedback	Indication range	0~65535

Display the PID setting value and feedback value. The value format is as follows:

PID setting = PID setting (percentage) * FA - 04

PID feedback = PID feedback (percentage) * FA - 04.

U0-18	PULSE input pulse frequency	Indication range	0.00kHz~100.00kHz
-------	-----------------------------	------------------	-------------------

Display X5 high speed pulse sampling frequency, minimum unit is 0.01 KHz.

U0-19	Feedback speed	Indication range	-320.00Hz~320.00Hz
U0-20	Remaining operating time	Indication range	0.0~6500.0 minutes
U0-21	AI1 pre-correction voltage	Indication range	0.000V~10.570V
U0-22	AI2 voltage / current before correction	Indication range	0.000V~10.570V 0.000mA~20.000mA
U0-23	AI3 voltage before correction	Indication range	-10.570V~10.570V

Display the actual value of the analog input sample voltage / current.

The voltage / current actually used has been linearly corrected so that the sampled voltage / current is in line with the actual input voltage / electricity. The flow deviation is smaller.

See U0 - 09, U0 - 10, U0 - 11 for the correction voltage / current actually used, and P3 group for the correction method.

U0-24	Linear velocity	Indication range	0 ~ 65535 m / min
-------	-----------------	------------------	-------------------

U0-27	PULSE input pulse frequency	Indication range	0: 65535Hz
-------	-----------------------------	------------------	------------

Display X5 high speed pulse sampling frequency in 1hz. It is the same data as u0 - 18, only showing different units.

U0-28	communication settings value	Indication range	communication settings value
-------	------------------------------	------------------	------------------------------

Display data written through address 0x1000.

U0-30	Main frequency X display	Indication range	0.00Hz~500.00Hz
-------	--------------------------	------------------	-----------------

Display the main frequency source X frequency setting.

U0-31	Auxiliary frequency Y display	Indication range	0.00Hz~500.00Hz
-------	-------------------------------	------------------	-----------------

Display the auxiliary frequency Y frequency setting.

U0-35	Target torque	Indication range	200.0% - 200.0%
-------	---------------	------------------	-----------------

Display the current torque upper limit setting.

U0-37	Power factor angle	Indication range	-
-------	--------------------	------------------	---

Display the current operating power factor angle.

U0-39	VF separates target voltage	Indication range	0v ~ rated voltage of motor
U0-40	VF separates output voltage	Indication range	0v ~ rated voltage of motor

Display the target output voltage and the current actual output voltage when operating in the VF separation state. VF separation is described in F3 group.

U0-41	X input status visual display	Indication range	<p>X7 X5 X3 X1 X6 X4 X2</p> <p>- light for valid extinction is not invalid</p>
-------	-------------------------------	------------------	--

U0-42	Do output status visual display	Indication range	-
-------	---------------------------------	------------------	---

U0-59	Set frequency	Indication range	-100.00% - 100.00%
U0-60	Running frequency	Indication range	-100.00% - 100.00%

Display the current set frequency and operating frequency. 100.00 % corresponds to the maximum frequency of the frequency inverter (F0 - 16).

U0-61	Operating state of frequency inverter	Indication range	0~65535
-------	---------------------------------------	------------------	---------

Display the frequency inverter operation status information.

The data definition format is as follows:

U0-61	Bit0	0: shutdown; 1: forward rotation; 2: reversal
	Bit1	
	Bit2	0: constant speed; 1: accelerating; 2: slow down
	Bit3	
	Bit4	0: bus voltage is normal; 1: under voltage

U0-62	Current fault code	Indication range	0~99
-------	--------------------	------------------	------

Display the current fault code.

U0-65	Upper torque limit	Indication range	-200.00% - 200.00%
-------	--------------------	------------------	--------------------

Display the current upper limit of the given torque.

U0-69	Frequency inverter module radiator temperature	Indication range	0°C ~ 120°C
-------	--	------------------	-------------

Display the temperature of the frequency inverter module IGBT.

The over-temperature protection values of IGBT modules of different models are different.

U0-70	Accumulated operating time	Indication range	0~65536h
U0-71	Cumulative power-on time	Indication range	0~65536h
U0-72	Cumulative power consumption	Indication range	0 ~ 65535 degrees
U0-73	Product Number	Indication range	-
U0-74	Software version number	Indication range	-
U0-76	Rated power of frequency converter	Indication range	-
U0-77	Frequency inverter G/P type machine	Indication range	-
U0-78	Rated voltage of frequency inverter	Indication range	-



Chapter VI Abnormal diagnosis

6.1 Fault alarm and countermeasures

Sr. No.	Fault name	Operation panel display	Troubleshooting of cause of failure	Countermeasures for fault handling
01	Frequency inverter unit protection	iGb	<ol style="list-style-type: none"> 1. Frequency inverter output circuit short circuit 2. Motor and frequency inverter wiring is too long 3. Module overheating 4. The internal wiring of the frequency inverter is loose 5. Abnormal main control board 6. Abnormal drive plate 7. Abnormal frequency inverter module 	<ol style="list-style-type: none"> 1. Eliminate peripheral faults 2. Install reactors or output filters 3. Check whether the air duct is blocked, fan is it working properly and excluded question 4. Plug in all connection lines 5. Seek technical support 6. Seek technical support 7. Seek technical support
02	Accelerated over current	oc1	<ol style="list-style-type: none"> 1. Frequency inverter output circuit is connected ground or short circuit 2. The control mode is vector and no parameter identification is carried out 3. The acceleration time is too short 4. Manual torque increase or V/F curve is not appropriate 5. low voltage 6. Start the rotating motor 7. Sudden loading during acceleration 8. The selection of frequency inverter is small 	<ol style="list-style-type: none"> 1. Eliminate peripheral faults 2. Identify motor parameters 3. Increase the acceleration time 4. Adjust the manual lifting torque or V/F curve 5. Adjust the voltage to the normal range 6. Choose speed tracking start or wait for the electric machine to stop before starting 7. Cancel the sudden load 8. Choose the frequency inverter with higher power level
03	Deceleration over current	oc2	<ol style="list-style-type: none"> 1. Frequency inverter output circuit is connected ground or short circuit 2. The control mode is vector and no parameter identification is carried out 3. The deceleration time is too short 4. Low voltage 5. Sudden load increase during deceleration 6. No brake unit and system added dynamic resistance 	<ol style="list-style-type: none"> 1. Eliminate peripheral faults 2. Identify motor parameters 3. Increase the deceleration time 4. Adjust the voltage to the normal range 5. Cancel the sudden load 6. Add brake unit and resistor
04	Constant speed over current	oc3	<ol style="list-style-type: none"> 1. Frequency inverter output circuit is connected ground or short circuit 2. The control mode is vector and there is no carry out parameter identification 3. Low voltage 4. Whether there is a sudden load in operation 5. The selection of frequency inverter is small 	<ol style="list-style-type: none"> 1. Eliminate peripheral faults 2. Identify motor parameters 3. Adjust the voltage to the normal range 4. Cancel the sudden load 5. Choose the frequency inverter with higher power level

Sr. No.	Fault name	Operation panel display	Troubleshooting of cause of failure	Countermeasures for fault handling
05	Accelerating over voltage	OU1	<ol style="list-style-type: none"> 1. High input voltage 2. There is an external force to drag the motor to run during acceleration 3. The acceleration time is too short 4. No brake unit and brake resistor are installed 	<ol style="list-style-type: none"> 1. Adjust the voltage to the normal range 2. Cancel the power or add brake resistance 3. Increase the acceleration time 4. Add brake unit and resistor
06	Deceleration over voltage	OU2	<ol style="list-style-type: none"> 1. High input voltage 2. There is an external force to drag the motor to run during deceleration 3. The deceleration time is too short 4. No brake unit and brake resistor are installed 	<ol style="list-style-type: none"> 1. Adjust the voltage to the normal range 2. Cancel the power or add brake resistance 3. Increase the deceleration time 4. Add brake unit and resistor
07	Constant speed over voltage	OU3	<ol style="list-style-type: none"> 1. High input voltage 2. There is external drag during operation moving motor operation 	<ol style="list-style-type: none"> 1. Adjust the voltage to the normal range 2. Cancel the power or add brake resistance
08	Control power failure	IPF	<ol style="list-style-type: none"> 1. The input voltage is not within the scope of the specification 	<ol style="list-style-type: none"> 1. Adjust the voltage to the standard range
09	Under voltage fault	LU	<ol style="list-style-type: none"> 1. Instantaneous power failure 2. Frequency inverter input terminal voltage is not within the scope of the specification requirements 3. Bus voltage is not normal 4. Rectifier bridge and buffer resistance is not normal 5. Abnormal drive plate 6. Abnormal control panel 	<ol style="list-style-type: none"> 1. Reset fault 2. Adjust the voltage to the normal range 3. Seek technical support 4. Seek technical support 5. Seek technical support 6. Seek technical support
10	frequency inverter overload	OL1	<ol style="list-style-type: none"> 1. Whether the load is too large or electricity occurs locked rotation of machine 2. The selection of frequency inverter is small 	<ol style="list-style-type: none"> 1. Reduce the load and check the motor and machine mechanical situation 2. Choose the frequency inverter with higher power level
11	Motor overload	OL2	<ol style="list-style-type: none"> 1. Is the setting of motor protection parameter F9 - 01 appropriate 2. Whether the load is too large or the electric machine is blocked 3. The selection of frequency inverter is small 	<ol style="list-style-type: none"> 1. Set this parameter correctly 2. Reduce the load and check the motor and machinery 3. Choose the frequency inverter with higher power level
12	Input phase missing	IPL	<ol style="list-style-type: none"> 1. Three-phase input power supply is not normal 2. Abnormal drive plate 3. Abnormal lightning protection plate 4. Abnormal main control board 	<ol style="list-style-type: none"> 1. Check and eliminate problems existing in peripheral lines 2. Seek technical support 3. Seek technical support 4. Seek technical support
13	Output phase missing	oPL	<ol style="list-style-type: none"> 1. The lead from the frequency inverter to the motor is not normal 2. The three-phase output of the frequency inverter is unbalanced when the motor is running 3. Abnormal drive plate 4. Module exception 	<ol style="list-style-type: none"> 1. Eliminate peripheral faults 2. Check whether the motor three-phase winding is normal and troubleshooting 3. Seek technical support 4. Seek technical support

Sr. No.	Fault name	Operation panel display	Troubleshooting of cause of failure	Countermeasures for fault handling
14	Module overheating	OH	<ol style="list-style-type: none"> 1. The ambient temperature is too high 2. The air duct is blocked 3. The fan is damaged 4. The module thermistor is damaged 5. The frequency inverter module is damaged 	<ol style="list-style-type: none"> 1. Reduce the ambient temperature 2. Clean up the air duct 3. Replace the fan 4. Replace thermistor 5. Replace the frequency inverter module
15	External equipment failure	EFF	<ol style="list-style-type: none"> 1. Input the signal of external failure through the multi-function terminal X. 	<ol style="list-style-type: none"> 1. Reset operation 2. Reset operation
16	Communication failure	COF	<ol style="list-style-type: none"> 1. The upper computer is not working normally 2. The communication line is abnormal 3. The communication expansion card FD - 00 is not set correctly 4. The setting of communication parameter FD group is incorrect 	<ol style="list-style-type: none"> 1. Check the PC wiring 2. Check the communication connection lines 3. Correctly set the type of communication expansion card 4. Correctly set communication parameters
17	Contact failure	rEF	<ol style="list-style-type: none"> 1. The drive board and power supply are not normal 2. Contactor is abnormal 	<ol style="list-style-type: none"> 1. Replace the drive board or power board 2. Replace contactors
18	Current detection fault	CUrF	<ol style="list-style-type: none"> 1. Check the hall element anomaly 2. abnormal drive plate 	<ol style="list-style-type: none"> 1. Replace hall element 2. Replace the drive plate
19	Motor tuning failure	FF	<ol style="list-style-type: none"> 1. Motor parameters are not set according to nameplate 2. Parameter identification process timed out 	<ol style="list-style-type: none"> 1. Set motor parameters correctly according to nameplate 2. Check the frequency inverter to motor lead
21	EEPROM Read / write fault	E2P	<ol style="list-style-type: none"> 1. EEPROM chip is damaged 	<ol style="list-style-type: none"> 1. Replace the main control board
22	Hardware failure of frequency inverter	HdF	<ol style="list-style-type: none"> 1. over voltage exists 2. There is over current 	<ol style="list-style-type: none"> 1. According to the over voltage fault treatment 2. According to the over current fault processing
23	Short circuit to ground	GndS	<ol style="list-style-type: none"> 1. Motor short circuit to ground 	<ol style="list-style-type: none"> 1. Replace cables or motors
26	Accumulated running time reaches failure	rRAF	<ol style="list-style-type: none"> 1. The accumulated running time reaches the set value 	<ol style="list-style-type: none"> 1. Use the parameter initialization function to clear the record information
27	User - defined fault 1	UEF1	<ol style="list-style-type: none"> 1. Input the user-defined fault 1 signal through the multi-function terminal X. 	<ol style="list-style-type: none"> 1. Reset operation
28	User - defined fault 2	UEF2	<ol style="list-style-type: none"> 1. Input the user-defined fault 2 signal through the multi-function terminal X. 	<ol style="list-style-type: none"> 1. Reset operation
29	Accumulated power-up time reaches failure	uFF	<ol style="list-style-type: none"> 1. The accumulated power-on time reaches the set value 	<ol style="list-style-type: none"> 1. Use the parameter initialization function to clear the record information
30	Off load fault	LLF	<ol style="list-style-type: none"> 1. The operating current of the frequency inverter is less than F9 - 27 	<ol style="list-style-type: none"> 1. Confirm whether the load is disconnected or F9 - 27. does F9 - 28 parameter settings conform to actual operating conditions
31	Loss of PID feedback during operation	PIdF	<ol style="list-style-type: none"> 1. PID feedback is less than FA - 26 set point 	<ol style="list-style-type: none"> 1. Check PID feedback signal or set FA - 26 as a suitable value

Sr. No.	Fault name	Operation panel display	Troubleshooting of cause of failure	Countermeasures for fault handling
40	Wave - by - wave current limiting fault		<ol style="list-style-type: none"> Whether the load is too large or the electric machine is blocked The selection of frequency inverter is small 	<ol style="list-style-type: none"> Reduce the load and check the motor and machinery Choose the frequency inverter with higher power level
41	Switching motor failure during operation		<ol style="list-style-type: none"> Change the current motor selection through terminals during the operation of the frequency inverter 	<ol style="list-style-type: none"> Switch the motor after the frequency inverter stops

6.2 Matters needing attention in commissioning:

1) How to shorten the actual acceleration time in V/F control mode?

Description of phenomenon	If the actual acceleration time of the motor is found during the acceleration process, it is far greater than the set acceleration time.
Solutions	When the target frequency is less than 2 times of the rated frequency, the FF - 10 "over current suppression starting current" can be increased, and the setting value of "over current suppression starting current" of the FF - 10 exceeds 170 each time, which is easy to cause "frequency inverter overload fault ol1" or "current limiting fault CBC".
	The target frequency is more than 2 times of the rated frequency. In the process of rapid acceleration, it is likely that the motor will stall (the output frequency of the frequency inverter has reached the target frequency, but the actual speed of the motor has been staying at a certain speed in the medium speed section, but the actual speed of the motor has been staying at a lower frequency or the acceleration time is too long). At this time, the FF - 13 "compensation coefficient for high-speed over current suppression current" can be adjusted to 100 %.

2) How to shorten the actual deceleration time under V/F control mode?

Description of phenomenon	If the actual deceleration time of the motor is found during deceleration, it is far greater than the set deceleration time.
Solutions	There is no additional braking resistor or feedback unit. Please increase F3 - 10 "V/F over excitation gain" setting by 20 % each time. After increasing F3 - 10 "V/F over-excitation gain" setting, if the motor oscillation over-voltage fault is caused, please reduce FF - 17 "over-voltage suppression voltage gain" setting.
	The inverter is equipped with a braking resistor or an energy feedback unit, and the input voltage level of the inverter is 360 - 420 v. Please adjust the FF - 32 "starting voltage of the braking unit" setting to 690 v and the F3 - 10 "V/F over-excitation gain" setting to 0.
	Using shutdown DC brake, recommended setting: F6 - 07 (stop DC brake starting frequency) 0.5 Hz F6 - 09 (stop DC brake current) 100 % F6 - 10 (stop DC brake time) 1S

3) How to limit the output current under V/F control mode and how to prevent over current fault under extreme impact load?

Description of phenomenon	In order to better protect the motor, control the upper limit of motor current
Solutions	The current upper limit can be controlled by adjusting FF - 10 "over current suppression starting current" and "current upper limit"
	Sudden acceleration, sudden deceleration, or impact load type may cause "over current fault oc" or "CBC current limiting fault". Please increase FF - 12 "over current suppression gain" setting value. If the adjustment is too large, it may cause current oscillation. At this time, please pay attention to callback.

4) How to limit bus voltage under V/F control mode to prevent over voltage fault?

Description of phenomenon	In constant speed power generation loads (e.g. kowtow pumping units, stone sawing machines) and shock surge loads (e.g. high-power punching machines), over-voltage faults can easily occur during operation.
Solutions	Constant speed intermittent power generation load: please lower FF - 14 "over voltage suppression starting voltage" setting value (factory value 770 v) and limit the upper limit value of bus voltage without specific requirements. it is recommended to adjust it to about 720 v. if over voltage fault still occurs, please adjust ff - 18 "over voltage suppression maximum rise limit frequency" setting value to 10 Hz or 20 Hz (for example, load with

	long cycle power generation time such as stone sawing machine).
	When an over voltage fault occurs in the sudden surge load, please lower the ff - 14 " over voltage suppression starting voltage" setting and suggest to adjust it to about 720 v.
	Large inertia rapid deceleration load: if the inverter is equipped with braking resistor and the input voltage level of the inverter is 360 ~ 420 v, please adjust FF - 32 " starting voltage of brake unit" setting to 690 v and F3 - 10 " V/F over-excitation gain" setting to 0. If the over voltage is still present, please lower the FF - 14 " over voltage suppression start voltage" setting, which is recommended to be adjusted to about 740 v.

6.3 F0.01 = 2 (V/F mode), common problem solving methods

Description of phenomenon	Solutions
Motor oscillation during operation	○ Increase the oscillation suppression parameter (F3 - 11) by 10 units (maximum adjustment to 100);
High power start-up over - current reporting	○ Lower the torque increase (F3 - 01) and adjust downward by 0.5 %.
The current in operation is too high	○ Set the rated voltage (F1 - 02) and rated frequency (F1 - 04) of the motor correctly; ○ Lower the torque increase (F3 - 01) and adjust downward by 0.5 %.
Motor noise is high	○ appropriately increase the carrier frequency value (F0 - 22) in units of 1.0 kHz; ○ (note: increasing the carrier frequency motor leakage current will increase)
Sudden unloading of heavy load to report over voltage, deceleration to report over voltage	○ Confirm that the over voltage suppression enable (ff - 15) is set to the enable state; Increase the over voltage suppression gain (ff - 16 / ff - 17, factory 30) by 10 units (maximum adjustment to 100); ○ Reduce the over voltage suppression operating voltage (ff - 14 factory 760 v) and reduce it in 10v units (minimum adjustment to 700 v);
Surge overload to report over - current, speed up reporting over - current	○ Increase the over current suppression gain (ff - 12 factory 20) by 10 units (maximum adjustment to 100); ○ Reduce over current suppression starting current (ff - 10 factory 150 %), decrease in 10 % (minimum adjustment to 50 %);

6.4 Fault analysis and countermeasures

Name	Panel display	Troubleshooting of cause of failure	Countermeasures for fault handling
Accelerated over current	OC1	There is a ground or short circuit in the frequency inverter output circuit	● Eliminate peripheral faults and detect if short circuit occurs in the motor or interrupt contactor
		The control mode is FVC or SVC and there is no parameter identification	● Set motor parameters according to the motor nameplate to identify motor parameters
		Quick acceleration condition, acceleration time setting is too short	● Increase the acceleration time

Name	Panel display	Troubleshooting of cause of failure	Countermeasures for fault handling
		Setting of over-loss rate suppression is not appropriate	<ul style="list-style-type: none"> • Confirm that the over current suppression function (FF - 11) has been enabled; • The setting value of over current suppression action current (FF - 10) is too large and is recommended to be adjusted within 120 % to 150 %. • The setting of over-current suppression gain (FF - 12) is too small, and it is recommended to adjust within 20 to 40;
		Manual torque boost or V/F curve not appropriate	<ul style="list-style-type: none"> • Adjust the manual lifting torque or V/F curve
		Start the rotating motor	<ul style="list-style-type: none"> • Select speed tracking to start or wait for the motor to stop before starting
		Subject to external interference	<ul style="list-style-type: none"> • Check the historical fault record. If the current value at the time of the fault is far from the value of the over current point, it is necessary to find the interference source. If there is no other interference source, it may be the drive board or hall element.
Deceleration over current	OC2	There is a ground or short circuit in the frequency inverter output circuit	<ul style="list-style-type: none"> • Eliminate peripheral faults and detect if short circuit occurs in the motor or interrupt contactor
		The control mode is FVC or SVC and there is no parameter identification	<ul style="list-style-type: none"> • Set motor parameters according to the motor nameplate to identify motor parameters
		The deceleration time is set too short under the condition of rapid deceleration.	<ul style="list-style-type: none"> • Increase deceleration time
		Setting of over-loss rate suppression is not appropriate	<ul style="list-style-type: none"> • Confirm that the over current suppression function (FF - 11) has been enabled; • The setting value of over current suppression action current (FF - 10) is too large and is recommended to be adjusted within 120 % to 150 %. • The setting of over-current suppression gain (FF - 12) is too small, and it is recommended to adjust within 20 to 40;
		Brake unit and brake resistor are not added	<ul style="list-style-type: none"> • Add brake unit and resistance
		Subject to external interference	<ul style="list-style-type: none"> • Check the historical fault record. If the current value at the time of the fault is far from the value of the over current point, it is necessary to find the interference source. If there is no other interference source, it may be the drive board or hall element.
Constant speed over current	OC3	There is a ground or short circuit in the frequency inverter output circuit	<ul style="list-style-type: none"> • Eliminate peripheral faults and detect if short circuit occurs in the motor or interrupt contactor
		The control mode is FVC or SVC and there is no parameter identification	<ul style="list-style-type: none"> • Set motor parameters according to the motor nameplate to identify motor parameters
		Quick acceleration condition, acceleration time setting is too short	<ul style="list-style-type: none"> • Increase the acceleration time
		Setting of over-loss rate suppression is not appropriate	<ul style="list-style-type: none"> • Confirm that the over current suppression function (FF - 11) has been enabled; • The setting value of over current suppression action current (FF - 10) is too large and is recommended to be adjusted within 120 % to 150 %. • The setting of over-current suppression gain (FF - 12) is too small, and it is recommended to adjust within 20 to 40;

Name	Panel display	Troubleshooting of cause of failure	Countermeasures for fault handling
		The selection of frequency inverter is small	<ul style="list-style-type: none"> In stable operation, if the operating current exceeds the rated current of the motor or the rated output current value of the frequency inverter, please select the frequency inverter with higher power level.
		Subject to external interference	<ul style="list-style-type: none"> Check the historical fault record. If the current value at the time of the fault is far from the value of the over current point, it is necessary to find the interference source. If there is no other interference source, it may be the drive board or hall element.
Accelerated over voltage	OU1	High input voltage	<ul style="list-style-type: none"> Adjust the voltage to the normal range
		There is an external force to drive the electric machine to run during acceleration	<ul style="list-style-type: none"> Cancel additional power or add braking resistance
		over voltage suppression setting is not appropriate	<ul style="list-style-type: none"> Confirm that the over voltage suppression function (FF - 15) has been enabled; over voltage suppression action voltage (FF - 14) set value is too large, which is recommended to be adjusted within 770 v to 700 v; The over voltage suppression gain (FF - 15 / 16) is set too small and is recommended to be adjusted within 30 to 50;
		There is no additional braking unit and braking electrical resistance	<ul style="list-style-type: none"> Add brake unit and resistance
		Acceleration time is too short	<ul style="list-style-type: none"> Increase the acceleration time
Deceleration over voltage	OU2	There is an external force to drag the motor during deceleration	<ul style="list-style-type: none"> Cancel additional power or add braking resistance
		over voltage suppression setting is not appropriate	<ul style="list-style-type: none"> Confirm that the over voltage suppression function (FF - 15) has been enabled; over voltage suppression action voltage (FF - 14) set value is too large, which is recommended to be adjusted within 770 v to 700 v; The over voltage suppression gain (FF - 15 / 16) is set too small and is recommended to be adjusted within 30 to 50;
		There is no additional braking unit and braking electrical resistance	<ul style="list-style-type: none"> Add brake unit and resistance
		Deceleration time is too short	<ul style="list-style-type: none"> Increase deceleration time
Constant rate over voltage	OU3	There is an external force to drag the motor during deceleration	<ul style="list-style-type: none"> Cancel additional power or add braking resistance
		over voltage suppression setting is not appropriate	<ul style="list-style-type: none"> Confirm that the over voltage suppression function (FF - 15) has been enabled
			<ul style="list-style-type: none"> over voltage suppression operation voltage (FF - 14) set value is too large, and it is recommended to adjust within 770 v ~ 700 v; over voltage suppression gain (FF - 15 / 16) set too
			<ul style="list-style-type: none"> Small, and it is recommended to adjust it within 30 to 50;
			<ul style="list-style-type: none"> over voltage suppression maximum rise limit frequency (ff - 18)
<ul style="list-style-type: none"> The setting is too small, it is recommended to adjust within 10 to 20; 			
Control power failure	IPF	The bus voltage fluctuates up and down at the under voltage point	<ul style="list-style-type: none"> Low input voltage or low input power. seek technical support

Name	Panel display	Troubleshooting of cause of failure	Countermeasures for fault handling
<p>Electric frequency inverter The display is normal and “EnEr”is displayed after operation. And stop the machine immediately</p>	<p>EnEr</p>	<p>The fan is damaged or jammed There is a short circuit in the wiring of the peripheral control terminal</p>	<ul style="list-style-type: none"> ● Replace the fan ● Eliminate external short circuit fault

Chapter VII Maintenance



Danger

- Do not repair and maintain the equipment with electricity, otherwise there is danger of electric shock!
- Confirm that maintenance and repair can only be carried out when the inverter bus voltage is lower than DC36V, whichever is 10 minutes after the power failure. Otherwise, the residual charge on the capacitor will cause harm to people!
- Please restore the front cover plate of the connection terminal before re - powering, otherwise it may cause personal injury!
- All pluggable plug-ins must be plugged and unplugged in case of power failure. Otherwise, there is a danger of causing secondary damage!



Danger

- Parameters must be set after replacing the frequency inverter, otherwise it may cause damage to other equipment in the system!
- Anti-static measures must be taken to dismantle and install the circuit board, which can prevent the damage of devices on the circuit board!
- Non-professional technical personnel shall carry out electrical detection or measurement during power-up or operation of the frequency inverter.

7.1 Maintenance and repair

7.1.1 Routine maintenance

Due to the influence of ambient temperature, humidity, dust and vibration, the devices inside the frequency inverter will age, causing potential failure of the frequency changer or reducing the service life of the frequency inverter. Therefore, it is necessary to carry out routine and regular maintenance and safeguard of the frequency inverter.

Routine inspection items:

- 1) Whether the operating environment of the frequency inverter has changed.
- 2) Whether the frequency inverter is overheated or has abnormal sound, and whether the frequency inverter cooling fan works normally.
- 3) Whether abnormal changes occur in the sound of the motor during its operation and whether vibration occurs

during its operation.

4) Whether the display value of the main operating parameters of the load is the same as the normal value.

Refer to the following table for routine inspection:

Inspection items	Inspection area	Inspection items
Operating Environment	Frequency inverter installation site	Temperature, humidity, dust, metal dust, harmful gases
Frequency inverter body	Inside the cabinet	Temperature, sound, peculiar smell
Display	LED monitor, meter	Whether the monitoring data is normal, such as input voltage, output current, output frequency output voltage, etc.
Loads	Motor and its wiring and connection terminals	The temperature and sound of the motor, the temperature of the wire and whether there is abnormal heat at the terminal

Daily cleaning:

1) Keep the doors and windows of the frequency inverter room closed and the filtering device of the cooling system in a normal and clean state.

2) The frequency inverter should always be kept in a clean state. Validly remove dust on the surface area of the frequency inverter to prevent dust accumulation from entering the frequency inverter. Especially the metal dust

7.1.2 Regular maintenance

Regular inspections should be carried out at places that are difficult to inspect during operation. The inspection shall be carried out at least ten minutes after the power failure. Refer to the following table for regular inspection items:

Inspection items	Check content	Countermeasures
Main loop terminal, control loop terminal	Whether the bolts and screws are loose, and whether there are any spark marks	Processing is normal
Fan cooling	Whether there is dust accumulation, whether the fan blade movement is blocked or whether there is abnormal sound and vibration, and whether the wind turbine housing is overheated and deformed	Replace defective products
Printed circuit board	Whether there is overheating or burning. Dust accumulation	The former changes plates as the case may be, while the latter blows the ash OFF with dry air of several atmospheres
Connector	Is it loose	Reinsert
Electrolytic capacitor	Is there any leakage or bubbling discoloration?	Replace with new products
Heat sink	Is there dust accumulation	Dust removal, air duct cleaning,
Insulation situation	Insulation of main circuit to ground	Use a 500 v megohmmeter and disconnect the control circuit from the main return circuit, the power supply and the load from the frequency inverter
Ambient air	Is it corroded	Transforming the environment

7.1.3 Replacement of vulnerable parts of frequency inverter

The vulnerable parts of the frequency inverter mainly include cooling fans and electrolytic capacitors for filtering, followed by printed circuit boards and fuses, etc. their life span is closely related to the environment in which they are used and their maintenance conditions. The user can determine the replacement period based on the running time. The typical life time of these devices is:

Device name	Life time
Fan	2-3 years
Electrolytic condenser	4-5 years
Printed circuit board	5-8 years

1) Fan cooling

Possible causes of damage: bearing wear and blade aging. Criteria: whether there is any crack in the fan blade, whether there is abnormal vibration sound when starting the machine, etc.

2) Filter electrolytic capacitor

Possible causes of damage: poor quality of input power supply, high ambient temperature, frequent load jump and electrolyte aging. Criteria: leakage of liquid, bulging of safety valve, determination of electrostatic capacitance, determination of insulation resistance

3) Printed circuit board

Possible causes of damage: aging insulation, deterioration of devices, loose connectors.

Criteria: broken insulation, burning marks on board surface, poor contact of plug - ins.

7.2 Storage

After the user purchases the frequency inverter, the following points must be paid attention to for temporary storage and long-term storage:

- When storing, try to pack it into the packing box of our Company according to the original packing.
- It should be placed in a room with a temperature of $-25\text{ }^{\circ}\text{C} \sim 65\text{ }^{\circ}\text{C}$ without moisture, dust, metal dust and good ventilation.
- Long - term storage will lead to deterioration of the electrolytic capacitor of the main circuit in the frequency inverter. It must be guaranteed to be energized once within one year to ensure that the electrical characteristics of the capacitor can be restored.
- Do not carry out withstand voltage test on the frequency inverter at will, which will lead to reduced service life.

Chapter VIII Peripheral equipment

8.1 Peripheral equipment and optional parts connection diagram

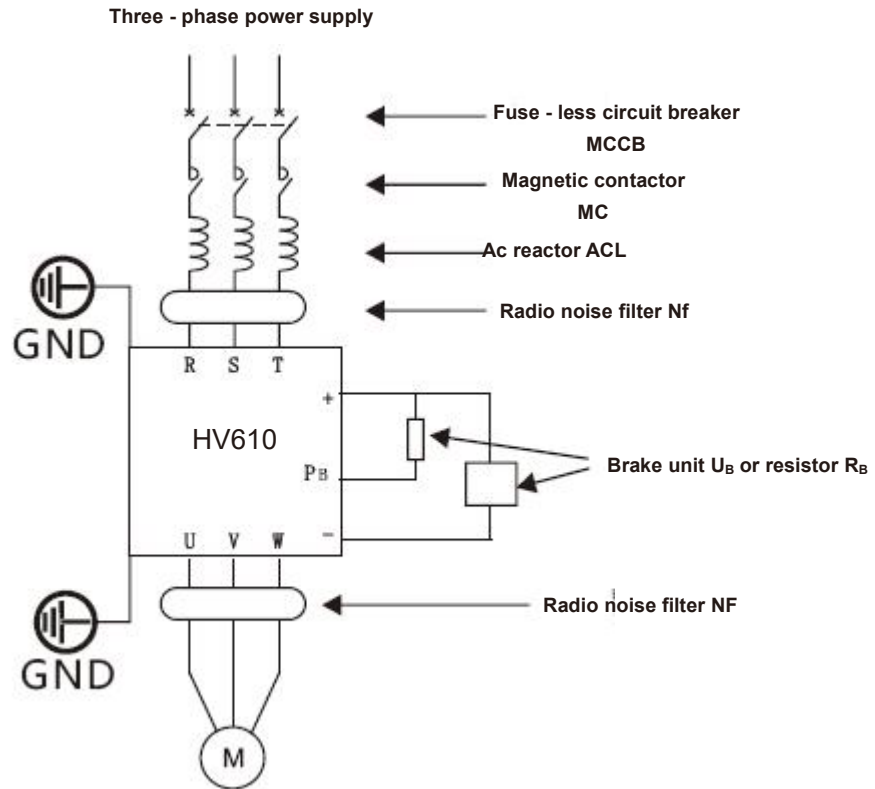

8.2 Functional description of peripheral equipment

Accessory name	Installation site	Brief description of function
Fuse - less circuit breaker	Front end of input loop	Power cut-off for downstream equipment when over current occurs
Contactator	Between the idle switch and the input side of the frequency inverter	Cut OFF the main power supply when the frequency inverter fails.
Ac input reactor	Input side of frequency inverter	Increasing the power factor at the input side; validly eliminate the higher harmonic on the input side
Brake unit or brake resistor	Main circuit of frequency inverter	Mainly used for fast braking

Ac output reactor	Between the frequency inverter output side and the motor. Install near the frequency inverter.	The output side of the frequency changer contains as many higher order harmonic waves as possible. When the motor is far away from the frequency inverter, there is a large distributed capacitance in the circuit. One of the harmonics may resonate in the loop, bringing about two effects: Damaging the insulation performance of the motor will damage the motor for a long time. A large leakage current is generated, causing frequent protection of the frequency inverter. As the distance between the frequency inverter and the motor exceeds 100 m, it is proposed to install an output AC reactor.
EMC input filter	Input side of frequency inverter	Reduce the transmission and radiation interference of the frequency changer to the outside; Reduce the transmission and conduction interference from the power supply end to the frequency inverter and improve the anti-interference capability of the frequency inverter.
Leakage protector	Input side of frequency inverter	To protect the frequency inverter and related circuit leakage
Capacitance box	Main circuit of frequency inverter	It is used in occasions where the power is cut OFF for a long time and the motor is continuously transported.

8.2.1 No fuse circuit breaker and contactor

1) The basic purpose of the fuse-less circuit breaker (commonly known as air switch) is to quickly cut OFF the fault current when the frequency inverter has an over current fault or other circuits below it have the same fault. It is used to prevent the frequency inverter and its circuits from causing power failure and to prevent the expansion of local accidents. In general power distribution systems, each should be equipped with its rated current varying according to the capacity of the frequency inverter. Refer to the table below for the recommended selection.

2) The contactor cuts OFF its main power supply when the frequency inverter fails and is used to prevent restart after the failure.

Frequent power-up and power-down operations (less than twice per minute) or direct start-up operations of the inverter through contactors should be avoided. Because the contactor is connected between the power supply and the input of the frequency inverter, if the contactor is used to control the starting and stopping of the frequency inverter, frequent charging and discharging can easily reduce the service life of the capacitor in the frequency inverter and also damage the contactor. Switch devices such as contactors shall not be installed between the output end of the frequency inverter and the motor. If it is really necessary (for example, switching between multi-frequency inverter systems or multi-motor systems), the on-off operation of the frequency inverter shall be ensured when there is no output, otherwise the main device in the frequency inverter may be damaged.

The recommended selection is shown in the following table.

Inverter specification	Fuse - less circuit breaker mccb (a)	Contactor MC (a)
3 - phase power supply, 380 v		
HV610-R75G3	4	9
HV610-1R5G3	6	9
HV610-2R2G3	10	12
HV610-004G3	16	18
HV610-5R5G3	20	25
HV610-7R5G3	25	25
HV610-011G3	32	32
HV610-015G3	40	40
HV610-018G3	50	50
HV610-022G3	63	63
HV610-030G3	80	80
HV610-037G3	100	100
HV610-045G3	125	115
HV610-055G3	160	125
HV610-075G3	200	185
HV610-093G3	225	225
HV610-110G3	315	330

HV610-132G3	315	400
HV610-160G3	350	400
HV610-185G3	400	500
HV610-200G3	400	500
HV610-220G3	500	500
HV610-250G3	500	630
HV610-280G3	630	630
HV610-315G3	750	750
HV610-355G3	800	800
HV610-400G3	800	800
HV610-450G3	1000	1000
HV610-500G3	1250	1250
HV610-560G3	1600	1600

8.2.2 AC input reactor

The device aims to change the voltage waveform distortion caused by the capacitive characteristics of the input end of the frequency inverter, validly eliminate the high-order harmonic wave on the input side and suppress the surge on the power supply side, thus improving the power factor, preventing other devices from being damaged due to the voltage waveform distortion, and eliminating the input current imbalance caused by the unbalance between the power supply phases. In addition, the higher harmonics of the power supply will cause damage to the frequency inverter.

8.2.3 AC output reactor

When the connection between the frequency inverter and the motor is too long, the distributed capacitance between the cables will increase, which is easy to generate capacitive high harmonic current, which will directly cause the output over current accident of the frequency inverter. It will also cause electromagnetic interference to other devices. Therefore, adding output reactors can reduce these impacts. As for the distributed capacitance between the output wiring of the frequency inverter, if the high harmonic current content in the wiring is high, it may cause resonance and generate leakage current. Leakage currents exceeding 100 m in length of motor cables may also be large. The solution is to reduce carrier frequency operation, and a more valid measure is to install output reactors.

It is recommended to use AC reactors under the following circumstances:

- 1) The power supply capacity of the frequency inverter is more than ten times that of the frequency inverter.
- 2) The same power supply as the frequency inverter is connected with a thyristor load or a power factor compensation device controlled by a switch, etc. where the quality of the power grid is relatively poor.
- 3) The three-phase unbalance degree of the power supply is greater than 3 %.

The recommended reactor parameters are shown in the following table.

Frequency inverter power (kw) (Rated voltage 380V)	Inlet wire reactor Current (a)	Inlet wire electricity Inductance (MH)	Output reactor electricity Stream (a)	Output reactor inductance (μ H)
0.75	3.4	8.0	2.1	2100
1.5	4.8	4.0	3.8	2100
2.2	6.2	3.2	5.1	1450
4.0	9.6	2.0	9	1100
5.5	14	1.5	13	800
7.5	18	1.2	17	650
11	26	0.8	25	330
15	35	0.6	32	250
18.5	41	0.5	37	200
22	50	0.42	45	180
30	62	0.32	60	90
37	80	0.26	75	80
45	96	0.21	91	60

55	120	0.18	112	40
75	165	0.13	150	35
93	180	0.11	176	30
110	225	0.09	210	20
132	260	0.08	253	16
160	305	0.07	304	13
185	350	0.06	340	11
200	385	0.06	380	11
220	430	0.05	426	9
250	470	0.04	465	9
280	530	0.03	520	8
315	600	0.03	600	6
355	700	0.03	700	5
400	800	0.03	800	5
450	1000	0.02	1000	4
500	1250	0.02	1000	3
560	1600	0.02	1250	3

8.2.4 Selection of energy consumption braking unit and braking resistance

When the motor is operating in the braking state, the motor will generate regenerative energy, which is electrical energy converted by the mechanical energy released when the rotating speed of the rotating motor changes from high to low and fed back to the main circuit being powered, which raises the voltage of the main circuit. The amount of the energy depends on the overall system characteristics and the parameter settings of the frequency inverter. In order to make the system work properly, this part of energy is dissipated by resistance, i.e. DC energy consumption braking.

1) The selection of the resistance value of the braking resistor RB

It also indirectly determines the magnitude of the braking torque of the system. If the braking torque is too small, it will not be restrained. The rise in the voltage of the main circuit will lead to over-voltage of the main circuit of the system and trip protection. If the braking torque is too large, the stable operation of the system will be affected. In order to stabilize the braking voltage of the system, it is generally chosen to be about 1.8 times of the rated AC input voltage. For 380 v standard motor control system, the working point of energy consumption braking is generally selected to be about 700 v. If this voltage is too low, braking may occur within the maximum operating range of the power supply. If this voltage is selected too high, over voltage protection action may occur.

Assuming KB is the mechanical energy / electrical energy conversion efficiency coefficient when the motor power is p (kw) feedback, usually kb = 0.7, then, when the brake operating point voltage u = 700 volts, according to the energy conservation relation that the motor generates energy that is completely absorbed by the brake resistor, the following relation exists when the motor has 100 % brake torque:

$$1000P*KB=U^2/RB$$

That is,

$$RB= U^2/1000 P*KB=700/P$$

Considering that KB is an empirical value and the duty cycle of the braking current, the actual maximum braking torque occurs at the extreme limit of KB = 1, at this time: KBmin = 0.7 * 700 / P ≈ 500 / P at this time, the braking current reaches the maximum. If this limit is exceeded, the device will be damaged.

2) The selection of braking resistor power

For the calculation of the power dissipated by the braking resistor itself is still fully absorbed by the braking resistor according to the regenerative energy and uses thermal energy. Considering the form of release, assuming that the resistance power is PB, the braking frequency KF, and the power margin ks, then

$$PB=P*KB*Kf*Ks$$

If select the K_s is 10/0.7, then $K_B \cdot K_s = 1$, then, the heat dissipation power of $P_B = P \cdot K_f$

Brake resistance depends on the braking frequency K_f . For general use, when occasional braking is required and braking does not need to occur frequently, K_f should be around 10%. For different load types, the values are usually as follows:

Oil field beam pumping unit: 10 % - 20 %

Elevators and cranes: 20 % - 40 %

Uncoilers and winders: 30 % - 50 %

Centrifuges: 40 % - 60 %

Since the regenerative braking energy varies according to the inertia, deceleration time, load type, braking frequency and other factors of the driving system, the selection of braking resistance should be based on the actual usage of the user. Generally speaking, the larger the inertia of the system, the faster the deceleration and the more frequent the braking, the smaller the resistance value selected and the greater the power of the resistor itself. The recommended values are shown in the following table.

Power supply	Motor power (kW)	Braking resistance value (W/Ω) $K_f=20\%$	Braking resistance quantity $K_f=20\%$	Braking resistance value (W/Ω) $K_f=40\%$	Braking resistance quantity $K_f=40\%$	Note
380V/3Φ	0.75	150W/800 Ω	1	300W/800 Ω	1	Built - in brake unit
380V/3Φ	1.5	300W/400 Ω	1	600W/400 Ω	1	Built - in brake unit
380V/3Φ	2.2	440W/250 Ω	1	880W/250 Ω	1	Built - in brake unit
380V/3Φ	4.0	800W/150 Ω	1	1100W/150 Ω	1	Built - in brake unit
380V/3Φ	5.5	1100W/100 Ω	1	2200W/100 Ω	1	Built - in brake unit
380V/3Φ	7.5	1500W/75 Ω	1	3000W/75 Ω	1	Built - in brake unit
380V/3Φ	11	2200W/50 Ω	1	4500W/50 Ω	1	Built - in brake unit
380V/3Φ	15	3000W/40 Ω	1	6000W/40 Ω	1	Built - in brake unit
380V/3Φ	18.5	4000W/30 Ω	1	4000W/60 Ω	2	Built - in brake unit
380V/3Φ	22	4500W/30 Ω	1	4500W/60 Ω	2	Built - in brake unit
380V/3Φ	30	6000W/20 Ω	1	6000W/40 Ω	2	External brake unit
380V/3Φ	37	4000W/28 Ω	2	5000W/42 Ω	3	External brake unit
380V/3Φ	45	4500W/20 Ω	2	6000W/30 Ω	3	External brake unit
380V/3Φ	55	5500W/16 Ω	2	5000W/40 Ω	5	External brake unit
380V/3Φ	75	5000W/19 Ω	3	5000W/39 Ω	6	External brake unit
380V/3Φ	93	6000W/15 Ω	3	5000W/40 Ω	8	External brake unit
380V/3Φ	110	5500W/18 Ω	4	5000W/40 Ω	9	External brake unit
380V/3Φ	132	4500W/22 Ω	6	6000W/33 Ω	9	External brake unit
380V/3Φ	160	4000W/24 Ω	8	5000W/39 Ω	13	External brake unit
380V/3Φ	185	4500W/20 Ω	8	5000W/39 Ω	15	External brake unit
380V/3Φ	200	5000W/20 Ω	8	5000W/40 Ω	16	External brake unit
380V/3Φ	220	5000W/20 Ω	9	5000W/40 Ω	18	External brake unit
380V/3Φ	250	5000W/20 Ω	10	5000W/38 Ω	20	External brake unit
380V/3Φ	280	5000W/20 Ω	11	5000W/41 Ω	23	External brake unit
380V/3Φ	315	5000W/20 Ω	13	5000W/39 Ω	26	External brake unit
380V/3Φ	355	5000W/20 Ω	14	5000W/42 Ω	30	External brake unit
380V/3Φ	400	5000W/20 Ω	16	5000W/38 Ω	32	External brake unit
380V/3Φ	450	5000W/18 Ω	18	5000W/36 Ω	36	External brake unit
380V/3Φ	500	5000W/18 Ω	20	5000W/36 Ω	40	External brake unit
380V/3Φ	560	5000W/18 Ω	22	5000W/36 Ω	45	External brake unit

3) Regarding the brake unit

No regenerative braking function is built in the 30kw G series type of frequency inverter and above specifications. When braking energy is needed, an energy consumption braking unit should be added. It should be noted when ordering. The brake unit shall be connected to the \ominus and \oplus terminals of the frequency inverter, and the brake resistor shall be connected to the external brake unit. The regenerative braking function is necessary when the braking torque of the machine itself cannot meet the application requirements, especially when it is under large inertia load, frequently broken or quickly stopped.

In situations requiring higher fast braking, even if an energy-consuming braking device is installed, the user is advised to use a feedback braking unit.

8.2.5 External DC reactor

The series of frequency inverters are all externally connected with DC reactors. If necessary, please consult the distributor or the factory directly for specific specifications.

8.2.6 Radio noise filter

The product is designed to meet the requirements of national standard GB/T12668.3 in terms of electromagnetic compatibility (that is, EMC refers to the ability of electrical equipment to operate in an electromagnetic interference environment, not to interfere with the electromagnetic environment, and to realize its functions stably). Frequency inverters need to meet the requirements of both electromagnetic interference and anti-electromagnetic interference. Electromagnetic interference mainly refers to radiation interference, conduction interference and harmonic interference of frequency inverters. Anti-electromagnetic interference mainly refers to the conduction immunity, radiation immunity, surge immunity, rapid burst immunity, ESD immunity and low frequency end immunity of the power supply.

The Company's products will be installed and used according to the following instructions, and will have good electromagnetic performance in general industrial environment.

There are two kinds of electromagnetic interference, one is the interference of the electromagnetic noise of the surrounding environment to the frequency inverter, and the other is the interference of the noise generated by the frequency inverter to the surrounding equipment.

1) Treatment method for interference of peripheral electromagnetic equipment to frequency inverter: Generally, the electromagnetic influence on frequency inverters is caused by the installation of a large number of relays, contactors or electromagnetic brakes in the vicinity of frequency inverters. When the frequency inverter is thus disturbed and misoperation occurs, it is recommended to install a radio noise filter at the input of the frequency inverter.

2) Measures for dealing with interference of frequency inverter to peripheral equipment: This part of the noise is divided into two types: one is the frequency inverter radiation interference, while the other is the frequency inverter conduction interference. These two kinds of interference make the peripheral electrical equipment subject to electromagnetic or electrostatic induction. Thus causing misoperation of the device According to different interference situations, adopt different methods to solve the problem:

a. The instruments, receivers and sensors used for measurement are generally weak in signal. If they are relatively close to the frequency inverter or in the same control cabinet, they are prone to interference and misoperation. Therefore, they should be kept away from the interference source as far as possible. do not arrange the signal lines in parallel with the power lines, especially do not tie them together in parallel; Shielded wires for signal lines and power lines and good grounding; Ferrite magnetic rings are added to the output side of the frequency changer (the selective suppression frequency is in the range of 30 - 1000 MHz) and 2 - 3 turns are wound in the same direction. For severe cases, the radio noise output filter can be added.

b. When the interfered equipment and the frequency inverter use the same power supply, they will cause conduction interference. If the above methods cannot eliminate interference, a radio noise filter should be installed between the frequency inverter and the power supply.

c If the length of the motor cable exceeds 100 m, it is required to add an output filter. The rated voltage of the frequency inverter is 380 v and the recommended products for the input radio noise filter are shown in the following table.

Adaptive motor power (kw)	Power supply capacity (kVA)	Rated input current (A)
0.75	1.5	3.4
1.5	3	5
2.2	4	5.8
4.0	5.9	10.5
5.5	8.9	14.6
7.5	11	20.5
11	17	26
15	21	35
18.5	24	38.5
22	30	46.5
30	40	62
37	57	76

45	69	92
55	85	113
75	114	157
93	134	180
110	160	214
132	192	256
160	231	307
185	242	350
200	250	385
220	280	430
250	355	465
280	396	525
315	445	590
355	500	660
400	540	780
450	630	885
500	700	920
500	760	1050

Precautions for installation:

1) The grounding wire of frequency inverter and other electrical products shall be well grounded; the filter must be connected to the same common ground as the PE end of the frequency inverter, otherwise it will seriously affect the EMC effect. The input filter is installed as close as possible to the power input of the frequency inverter.

Shield cables for the control signal lines and lead wires of the test lines of the frequency inverter and reliably ground the shield layer.

2) The power input and output lines and weak current signal lines (e.g. control lines) of the frequency inverter should not be arranged in parallel as far as possible, and should be arranged vertically when conditions permit.

3) It is recommended to use shielded cable or steel pipe to shield the power line for the output power line of the frequency inverter, and the shielding layer should be reliably grounded.

4) It is recommended to use twisted pair shielding control lines for the leads of the interfered equipment and reliably ground the shielding layer;

5) If peripheral equipment is grounded separately, interference caused by leakage current of frequency inverter grounding line can be eliminated.

8.2.7 Leakage protector

There are two forms of leakage current when using frequency inverter: one is leakage current between wires, the other is leakage current to ground. The former leakage current has been explained in the section of reactor. This section only discusses leakage current to floor drain.

There may be insulation and leakage for other reasons in the frequency inverter and its accessories and related circuits. Moreover, because there are distributed capacitors in the frequency inverter, the motor and its wiring with the earth, the larger the distributed capacitor is, the larger the leakage current is. However, this series frequency inverter is designed with low noise, so the carrier frequency is higher, the higher the carrier frequency is, the greater the leakage current is. The leakage current will increase as the return current increases, so when the motor power is high, the corresponding leakage current will be high. Validly reduce the distance between the frequency inverter and the motor to reduce the distributed capacitance. The carrier frequency can be lowered to reduce leakage current, but lowering the carrier frequency will result in increased motor noise. Installing reactors is also a valid way to solve leakage current. However, there must be a current to the floor drain. Installing a leakage protector is also a valid method to protect the frequency inverter.

The leakage protector shall be installed between the incoming line end of the frequency inverter and the mccb of

the air switch. The criterion for selecting its specifications is that the operating current of the leakage protector shall not be less than ten times that of the line when the frequency inverter is not used under the power frequency power supply.

8.2.8 Capacitance box

This peripheral device is specially used for occasions where the power failure time is long and the motor needs continuous operation. Although this series frequency inverter has the advanced function of instant stop, the capacitor box can still be used under the special circumstances of specific requirements (the instantaneous power failure of the power supply is greater than 20 ms). If necessary, specify the specific requirements when ordering.

Since the installation of this external device will affect some parameters in the machine, so you do not want users to install it themselves. Please contact our Company.

Chapter IX Quality Assurance

9.1 Quality commitment

The quality assurance of the product shall be handled according to the following regulations:

The warranty scope only refers to the frequency inverter body, and the warranty period starts from the Company's delivery date.

The warranty period of the product is 18 months after purchase, even if the product fails due to the following reasons inside, also belong to paid maintenance:

- Problems caused by incorrect operation or unauthorized self-repair and renovation;
- Problems caused by the use of frequency inverters beyond the standard specification requirements;
- Damage caused by falling or rough handling after purchase;
- Aging or failure of devices caused by use in environments that do not meet the requirements of this specification;
- The frequency inverter is damaged due to incorrect connection wires;
- Failures caused by earthquakes, fires, geomantic disasters, lightning strikes, abnormal voltages or other natural disasters and disasters.

The Company has the right to entrust others to take care of the warranty of the faulty products.

The quality assurance content that is truly the responsibility of the Company:

- Return, exchange and warranty within one month of shipment;
- Replacement and warranty within three months of shipment;
- Warranty for 18 months after shipment

Relevant service fees shall be calculated based on actual fees. If there is any agreement, the principle of agreement first shall be applied.

The Company's sales, production and agency agencies throughout the country can provide after-sales service to the product.

Our Company reserves the right to interpret this agreement.

Additional instructions

On the issue of exemption from liability

- The Company cannot bear any liability arising from or induced by the use of the product in violation of the provisions of this specification.
- The Company is not responsible for compensation for the loss, ripple or secondary damage caused to you by the failure of the product.

Instructions for users

- ◆ This instruction manual is only applicable to this series of products.
- ◆ The Company has lifelong responsibility for the product and provides all services related to the use of the product.
- ◆ Although the product is designed and manufactured under strict quality control, please ask our Company in advance if it is used for the following purposes that may endanger human body or its life due to its failure or operational error.
 - Used for the transportation equipment
 - Medical device
 - Nuclear and electrical equipment
 - Aviation and space devices
 - Various safety devices
 - Other special purposes

About hope for users

We sincerely hope that the vast number of users will put forward their opinions or suggestions on the Company's product design, performance, quality and service, and we would appreciate it very much.

Appendix A Introduction of Communication

HV610 provides standard RS485 communication interface and realizes communication link through MODBUS communication protocol. Through PC / PLC and other upper computers, network control of " single / Multi-Agent " can be realized (setting frequency inverter control command and operating frequency, modifying functional parameters, monitoring frequency inverter operating status and fault information) to adapt to specific application requirements.

1 Basic communication settings

1.1 Select communication protocol

MODBUS is only supported by default for standard products that choose communication protocols. If other communication protocols are required, you need to purchase another communication card and set FD - 00 and related parameters..

FD - 00 communication protocol	0~3 【0】
--------------------------------	---------

0: MODBUS protocol

1.2 Setting data transmission rate

Data transmission rate refers to the data transmission rate between the frequency inverter and the upper computer.

FD - 01 communication baud rate	0~0005 【0005】
---------------------------------	---------------

Protocol baud rate of MODBUS bits 0: 300 bps

- 1: 600BPS
- 2: 1200BPS
- 3: 2400BPS
- 4: 4800BPS
- 5: 9600BPS
- 6: 19200BPS
- 7: 38400BPS
- 8: 57600BPS
- 9: 115200BPS

1.3 Set data format

FD - 02 data format	0~3 【0】
---------------------	---------

- 0: No check: data format < 8, N, 2 > (1 - bit start bit, 8 - bit data bit, 2 - bit stop bit, no check)
- 1: Even check: data format < 8, E, 1 > (1 bit start bit, 8 bit data bit, 1 bit stop bit, even check)
- 2: Odd check: data format < 8, O, 1 > (1 bit start bit, 8 bit data bit, 1 bit stop bit, odd check)
- 3. No check: data format < 8, N, 1 > (1 - bit start bit, 8 - bit data bit, 1 - bit stop bit, no check)

Note: The data format of the frequency inverter and the master station must be the same, otherwise normal communication will not be possible.

1.4 Set the local address

FD - 03 set the local address	0~247 【1】
-------------------------------	-----------

In Modbus communication, a maximum of 247 units can be connected to the network. The address of each frequency inverter must be unique.

1.5 communication timeout and response

FD - 05 communication timeout	0.1~60.0s 【0.0s】
-------------------------------	------------------

When FD - 05 = 0.0, the communication timeout detection is invalid.

When FD - 05 is non - zero, then the time between the current command and the next communication command exceeds the FD - 05 setting, then the frequency inverter will fail to communicate and the operation panel will display cof.

2 Modbus protocol description

2.1 protocol description

Protocol brief introduction

① Modbus master slave protocol. Only one device can send commands in the network at any time.

② The master station exchanges management information by polling the slave stations. No slave station can send messages without the approval of the master station. If there is an error in data exchange, if the master station does not receive a response, the slave station absent from the poll will be interrogated again.

③ If the slave station cannot recognize the information sent by the master station, it will send an abnormal response to the master station.

④ If there is no direct communication between the slave station and the slave station, one slave station's data must be read out through the master station's software and sent to another slave station Two types of dialogues can be realized between the master station and the slave station:

The master station sends a request to the slave station and waits for the slave station to respond.

The master station sends requests to all slave stations without waiting for their response broadcast mode.

Transfer

The transmission mode is RTU (remote terminal unit) mode, and the frame does not contain any message header bytes or message word segment terminators. The classic RTU frame format is shown in the following table:

Slave address	Function code	Data	CRC
1 byte	1 byte	0 ... 252 bytes	CRC low bit

① Address 0 (reserved), used for broadcasting.

② All slave nodes must identify the broadcast address of the write function but do not need to respond.

③ The master node does not have a specific address, only the slave node must configure the address.

RTU transmission method has four character formats, as follows:

① 1 - bit start bit, 8 - bit data bit, 2 - bit stop bit, no check

② 1 - bit start bit, 8 - bit data bit, 1 - bit stop bit, even check

③ 1 - bit start bit, 8 - bit data bit, 1 - bit stop bit, odd check

④ 1 - bit start bit, 8 - bit data bit, 1 - bit stop bit, no check

Characters or bytes are transmitted from left to right, as shown in the following table:

< - least significant bit (LSB)					Most significant bit (msb) - >					
Starting bit	1	2	3	4	5	6	7	8	Stop bit	Stop bit
Starting bit	1	2	3	4	5	6	7	8	Even check	Stop bit
Starting bit	1	2	3	4	5	6	7	8	Odd check	Stop bit
Starting bit	1	2	3	4	5	6	7	8	Stop bit	-

The above table shows that RTU transmission mode

Information frames are separated by at least at static interval of 3.5 bytes. The entire frame must be transmitted in a continuous stream of bytes. If the interval between more than two frames is less than 3.5 bytes, the receiving device will mistakenly assume that the slave station address of the second frame is the continuation of the previous frame. CRC check failed due to frame disorder, resulting in communication failure. If the rest interval between two bytes exceeds 1.5 bytes, the receiving device will consider the information frame incomplete and discard it.

2.2 MODBUS communication interface

Modbus realizes communication through RS485 interface, that is, through 485 + / 485 - link on the control panel.

2.3 MODBUS function and information format

Modbus's main function is to read (read) and modify (write) parameters. Different function instructions determine different operation requests. The MODBUS function of HV610 is shown in the following table:

Functional instruction	Function name	Broadcasting	Maximum value of N
0x03	Reading N register words	No	16
0x06	Modify a register (power down save)	Yes	1
0x05	Modify a register (power down does not save)	Yes	1

Different function commands determine different Modbus information formats, as follows:

Slave number	0x03	Starting word address	Word number	CRC16
		High low	High low	Low high

Function instruction 3 _ host request

Slave number	0x03	Bytes	Starting word value	-	Last word value	CRC16
		High low	High low	-	High low	Low high

Function command 3 _ host response

Slave number	0x06	Starting word address	Data	CRC16
		High low	High low	Low high

Function instruction 6 _ host request and slave response (same format)

Slave number	0x05	Starting word address	Data	CRC16
		High low	High low	Low high

Function instruction 5 _ host request and slave response (same format)

Function example

Function 0x03: read n register words, read range 1 ~ 16

The slave address is 01h, and two consecutive data words are read first. The starting address is F000H of the communication parameter register. The structure of the frame is described as follows:

Message start	3.5 bytes of transmission time
Slave address	0 1H
Modbus function code	0 3H
Starting address high byte	F 0H
Starting address low byte	0 0H
High byte of data	0 0H
Low byte of data	0 2H
CRC low byte	F 7H
CRC high byte	0 BH
End of message	3.5 bytes of transmission time

Function instruction 0x03 requests frame

Message start	3.5 bytes of transmission time
Slave address	0 1H
Modbus function code	0 3H
High number of data bytes	0 0H
Low number of data bytes	0 4H
Register F000H data high byte	0 0H
Register F000H data high byte	0 BH
Register F000H data high byte	0 0H
Register F000H data high byte	0 0H
CRC low byte	
CRC high byte	
End of message	3.5 bytes of transmission time

Function instruction 0x03 slave responds to frame

Function 0x06: modify a register word.

Note: frequent write operations can damage internal memory!

① Execute the write command, and the data will be written into the internal register. The memory has a limit on the number of write operations. If the limit is exceeded, the memory address will be destroyed. Please avoid frequent write operations.

② If it is necessary to write to an address frequently, it is recommended to use function instruction 0x05.

Example: slave address is 01h. Now modify the contents of a register. Its communication register address is f08h, and the written content is 1388 H. The structure of the frame is described as follows:

Message start	3.5 bytes of transmission time
Slave address	01H
Modbus function code	06H
Starting address high byte	F0H
Starting address low byte	08H
High byte of data	00H
Low byte of data	01H
CRC low byte	FCH
CRC high byte	C8H
End of message	3.5 bytes of transmission time

Function 0x06 host requests

Message start	3.5 bytes of transmission time
Slave address	01H
Modbus function code	06H
Starting address high byte	F0H
Starting address low byte	08H
High byte of data	00H
Low byte of data	01H
CRC low byte	CFH
CRC high byte	C8H
End of message	3.5 bytes of transmission time

Function 0x06 slave responds.

Function 0x05: modify a register word and write it into ram.

Note: the write operation instruction only modifies ram, does not store internal memory, and does not save when power fails!

Example: slave address is 01h, now modify the contents of a register whose communication register address is f08h, written in the content is 01h. The structure of the frame is described as follows:

Message start	3.5 bytes of transmission time
Slave address	01H
Modbus function code	05H
Starting address high byte	F0H

Starting address low byte	08H
High byte of data	00H
Low byte of data	01H
CRC low byte	BEH
CRC high byte	C8H
End of message	3.5 bytes of transmission time

Function 0x05 host requests

Message start	3.5 bytes of transmission time
Slave address	01H
Modbus function code	05H
Starting address high byte	F0H
Starting address low byte	08H
High byte of data	00H
Low byte of data	01H
CRC low byte	BEH
CRC high byte	C8H
End of message	3.5 bytes of transmission time

Function 0x05 slave responds.

Fault code and exception code

If the slave successfully receives a request but cannot execute it, the slave will return an exception response containing the fault code and the exception generation code, informing the host of the error message.

The fault code format is in two formats:

When FD - 06 = 0, the exception code is shown in the following table:

Slave code	Fault code	Exception code	CRC16
	8000H		Low high

The HV610 exception code is as follows:

- ① 1 = parameter cannot be modified because password protection is turned on.
- ② 2 = slave cannot recognize the requested function instruction. That is (not 3, 5, 6)
- ③ 3 = CRC check error.
- ④ 4 = slave does not contain the requested word address.
- ⑤ 5 = this parameter is invalid and out of range.
- ⑥ 6 = parameter is read-only and cannot be modified.
- ⑦ 7 = the system locks this parameter.

When FD - 06 = 1, the exception code is shown in the following table:

Slave code	Fault code	Exception code	CRC16
	Function instruction + 0x80		Low high

- ① 1 = Parameter cannot be modified because password protection is turned on.
- ② 2 = Slave cannot recognize the requested function instruction. That is (not 3, 5, 6) .
- ③ 3 = CRC check error.
- ④ 4 = Slave does not contain the requested word address.
- ⑤ 5 = This parameter is invalid and out of range.
- ⑥ 6 = Parameter is read-only and cannot be modified.
- ⑦ 7 = The system locks this parameter.

2.4 Communication mapping register address distribution

Frequency inverter parameter register set and function code one-to-one correspondence. Read and write frequency inverter parameter registers via Modbus communication the contents in the can realize the read-write operation of the corresponding function code. The read-write characteristics and scope of the function codes follow the definition of the function parameters of the frequency inverter. The address of the frequency inverter parameter register consists of a high byte and a low byte. The high byte code function code group number and the low byte represent the function code serial number in the corresponding function code group. The corresponding relationship is shown in the following table:

Read operation and write EEPROM operation (write saved by power failure) address mapping table:

Address high byte	0xF0	0x F1	0x F2	0x F3	0x F4	0x F5	0x F6	0x F7
Parameter group	F0 group	F1 group	F2 group	F3 group	F4 group	F5 group	F6 group	F7 group
Address high byte	0x F8	0x F9	0x FA	0x FB	0x FC	0x FD	0x FE	0x FF
Parameter group	F8 group	F9 group	FA group	FB group	FC group	FD group	FE group	FF group
Address high byte	0x 1F	0x A0	0x A1	0x A2	0 x 70	0x AF		
Parameter group	FH group	Po group	P1 group	P2 group	U0 group	E0 group		

Write only ram operation (write without saving when power fails) address mapping table:

Address high byte	0x00	0 x 01	0 x 02	0 x 03	0 x 04	0 x 05	0 x 06	0 x 07
Parameter group	F0 group	F1 group	F2 group	F3 group	F4 group	F5 group	F6 group	F7 group
Address high byte	0 x 08	0 x 09	0x 0A	0x 0B	0x 0C	0x 0D	0x 0E	0x 0F
Parameter group	F8 group	F9 group	FA group	FB group	FC group	FD group	FE group	FF group
Address high byte	0x 2F	0 x 40	0 x 41	0 x 42				
Parameter group	FH group	Po group	P1 group	P2 group				

Note: frequent write operations can damage internal memory!

① Execute the write command, and the data will be written into the internal register. The memory has a limit on the number of write operations. If the limit is exceeded, the memory address will be destroyed. Please avoid frequent write operations.

② If it is necessary to write to an address frequently, it is recommended to use the function instruction 0x05 or the address of the write ram operation.

Communication control frequency / torque special register address 1000 h (readable / writable)

When frequency source F0 - 03 = 9, the setting frequency of the frequency inverter can be modified by writing data to this address. Scope of data - 10,000 - 10,000, corresponding to a given value of - 100.00 % - 100.00 %.

The communication reads the 1000 h register value, and the response data word is the communication setting value.

Common monitoring address (read - only)

Communication address	Address description
1001H	Operating frequency (unit: 0.01 Hz)
1002H	Bus voltage (unit: 1v)
1003H	Output voltage (unit: 1v)
1004H	Output current (unit: 1v)
1005H	Output power (unit: 0.1 kw)
1006H	Output torque (unit: 0.1 %)
1007H	running speed
1008H	X input terminal status
1009H	Output terminal status
100AH	AI1 voltage (unit: 0.01 v)
100BH	AI2 voltage (unit: 0.01 v)
100CH	AI3 voltage (unit: 0.01 v)
100FH	loading speed
1013H	Feedback frequency (unit: 0.1 Hz)
101EH	Encoder feedback frequency (unit: 0.01 Hz)

Communication control special register address 2000 H (write only)

value	Description
1	Forward running
2	Reverse operation
3	Forward jog
4	Reverse JOG
5	Free stop
6	Deceleration shutdown
7	Fault reset

The control mode is F0 -02 = 2. By writing the corresponding data word into the communication control command word 2000 H, the operation / stop / jog / reset of the frequency inverter can be controlled.

Communication control output terminal special register address 2001 h (write only)

When the terminal output function is set to 20, the state of the output terminal can be controlled by writing a response value to the register through communication. The specific definitions of each are shown in the following table:

Position	value	Description
0	0	DO1 output is invalid
	1	DO1 output is valid
1	0	Reserve
	1	Reserve
2	0	Relay 1 output is invalid
	1	Relay 1 output is valid
3	0	Reserve
	1	Reserve
4	0	FM output is invalid
	1	FM output valid

Communication control AO1 output special register 2002H (write only)

When the analog output AO1 output function is selected to be 12: communication setting, the communication address can be used to realize the right the analog ao1 control of the frequency inverter defines a quantization relation of 0 ~ 7 FFF representing 0 % ~ 100 %.

Communication control AO2 output special register 2003H (write only)

When the analog output AO2 output function is selected to be 12: communication setting, the communication address can be used to realize the right the analog ao2 control of the frequency inverter defines a quantization relation of 0 ~ 7 FFF representing 0 % ~ 100 %.

Communication control FMP output special register 2004 h (write only)

When the pulse output FMP output function is selected to be 12: communication setting, through this communication address, it is possible to realize the right the frequency inverter pulse quantity FMP is controlled, and the defined quantization relation is 0 ~ 7 FFF, which represents 0 % ~ 100 %.

Communication status feedback special register address 3000 h (read - only).

Reading this register can monitor the current running status of the frequency inverter. This register is read - only. Each value. Define the following table:

value	Description
1	Forward running
2	Reverse operation
3	Stop

Communication read fault code special register address 8000 h (read - only).

By reading this register, the current fault code of the frequency inverter can be monitored. When there is no fault, the read data word is 0.

2.5 CRC 16 check method:

CRC (cyclic redundancy check) uses RTU frame format, and the message includes error detection domain based on CRC method. The CRC field detects the content of the entire message. The CRC field is two bytes and contains 16 - bit binary values. It is calculated by the transmission device and added to the message. The receiving device recalculates the CRC of the received message and compares it with the value in the received CRC field. If the two CRC values are not equal, then there is an error in the transmission.

CRC is stored in 0xffff first, and then calls a procedure to process the consecutive 8 - bit bytes in the message with the value in the current register. Only 8bit data in each character is valid for CRC, and neither start bit nor stop bit nor parity bit is valid.

During CRC generation, each 8 - bit character is exclusive or (xor) different from the register contents. The result is shifted toward the least significant bit and the most significant bit is filled with 0. LSB is extracted and detected. If LSB is 1, the register is different from the preset value or if LSB is 0, it will not be carried out. The whole process has to be repeated eight times. After the last bit (bit 8) is completed, the next 8 - bit byte differs from the current value of the register or separately. The value in the final register is the CRC value after all bytes in the message are executed.

When CRC is added to the message, the low byte is added first and then the high byte. The CRC simple function is as follows:

```
unsigned int crc_chk_value (unsigned char *data_value,unsigned char length) {
    unsigned int crc_value=0xFFFF;
    int i;
    while (length-->0) {
        crc_value^=*data_value++;
        for (i=0;i<8;i++) {
            if (crc_value&0x0001) {
                crc_value= (crc_value>>1) ^0xa001;
            }
            else {
                crc_value=crc_value>>1;
            }
        }
    }
    return (crc_value) ;
}
```

2.6 Set up of communication network

Communication network as shown in the figure below, the main station is PC, PLC or other communication equipment, and the frequency inverters are slave station, sampling shielded twisted cable shall be connected. The slave station of the network terminal needs external terminal resistance, which is recommended to be 120 ohms and 0.25 W.

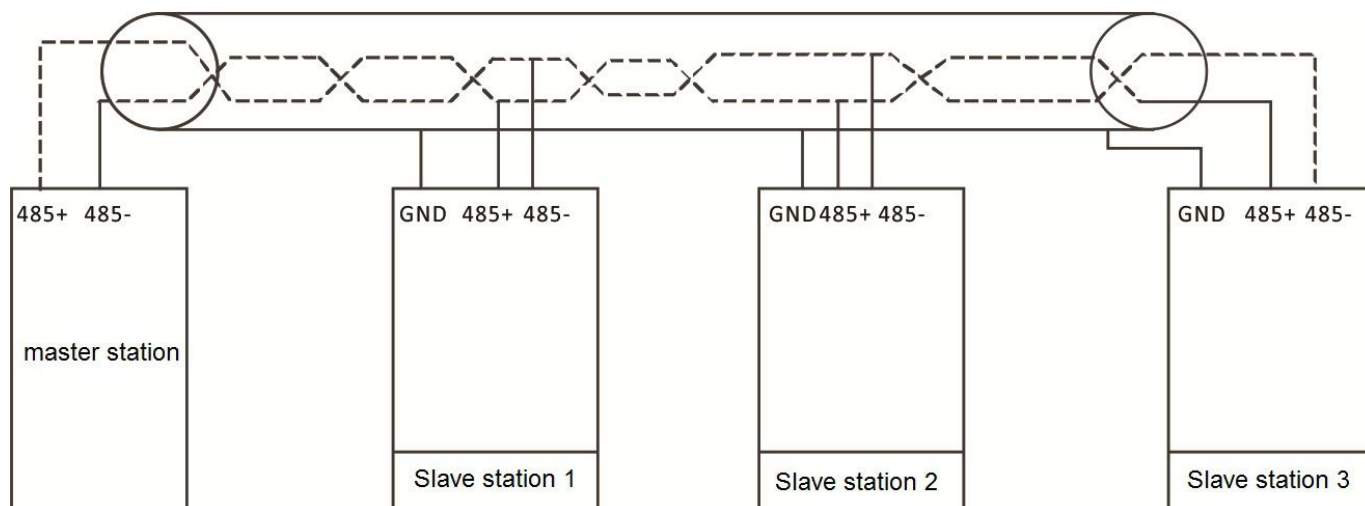

Network topology map.

Notes:

Only when the frequency inverter is powered OFF can it be connected.

Networking suggestion

- ① connect RS485 link with cable shielded by double glue.
- ② Modbus cable should be far away from power drive line (at least 30cm).
- ③ avoid crossing Modbus cable and power line. If it cannot be avoided, please cross vertically.
- ④ connect the cable shielding layer to the protective ground, or connect the cable shielding layer to the equipment ground if the equipment ground is already connected to the protective ground. Do not connect RS485 network directly to ground at any point.
- ⑤ Under any circumstances, avoid grounding wires forming a loop.

Appendix B Technical specification for HV610 series frequency inverters

Item	Specifications
Basic Functionalist	Highest frequency Vector control: 0 ~ 500 Hz V/F control: 0: 3200Hz
	Carrier frequency 0.5kHz~16kHz The carrier frequency can be automatically adjusted according to the load characteristics.
	Input frequency resolution Digital setting: 0.01 Hz Analog setting: highest frequency * 0.025 %
	Control mode 1: Open loop vector control 2: Closed loop vector control 3: V/F control
	Start torque G type: 0.5 Hz / 150 % P type: 0.5 Hz / 100 %
	Speed control range 1: 100
	Speed stabilization accuracy ±0.5%
	Torque control accuracy ±5%
	Overload capacity Model G machine: 150 % rated current 60s; 180 % rated current 3s.
	Torque increase Automatic torque increase; The manual torque is increased by 0.1 % - 30.0 %
	V/F curve Three ways: linear; Multipoint type; N - power V/F curve (power 1.2, power 1.4, power 1.6, power 1.8, power 2)
	V/F separation Two methods: full separation and half separation
	Acceleration and deceleration curve Straight line or S curve acceleration and deceleration mode. Four kinds of acceleration and deceleration times, The acceleration and deceleration time range is 0.0 to 6500.0 S.
	DC brake DC braking frequency: 0.00 Hz ~ maximum frequency Braking time: 0.0s ~ 36.0s Brake action current value: 0.0 % - 100.0 %
	JOG JOG frequency range: 0.00 Hz ~ 50.00 Hz. JOG acceleration and deceleration time 0.0s ~ 6500.0 s.
	Simple PLC, multi-stage speed operation Up to 16 - speed operation via built-in PLC or control terminal
Built - in PID Closed-loop control system capable of conveniently realize process control	
Automatic voltage regulation (AVR) When the grid voltage changes, the output voltage can be automatically kept constant.	

	over voltage and over-loss rate control	Automatically limit the current and voltage during operation to prevent frequent over current and over voltage trips.
	Fast current limiting function	Minimize over-current faults and protect the normal operation of the frequency inverter
	Torque limitation and control	The " excavator" feature automatically limits the torque during operation to prevent frequent over current trips; Open loop vector mode can realize torque control
Individualized performance	Outstanding performance	Using high performance current vector control technology to realize asynchronous motor control
	Stop at once	When the instantaneous power failure occurs, the load feedback energy compensates for the voltage drop and the frequency inverter will continue to operate for a short period of time.
	Fast current limiting	Avoiding frequent over current faults of the frequency inverter
	Timing control	Timing control function: set the time range from 0.0 min to 6500.0 min
	Switch between two motors	Two sets of motor parameters can realize switching control of two motors
	Bus support	Supports a variety of Fieldbus: RS - 485,PROFIBUS
Running	Command source	Operation panel setting, control terminal setting, serial communication port setting. Can be switched in various ways
	frequency source	Multiple frequency sources: digital setting, analog voltage setting, analog current setting, pulse setting, serial port setting. Can be switched in various ways
	Auxiliary frequency source	Various auxiliary frequency sources. Can flexibly realize auxiliary frequency fine tuning and frequency synthesis
	Input terminal	Standard 7 digital input terminals, of which 1 supports high-speed pulse input of up to 100 khz; Three analog input terminals, one supporting only 0 ~ 10v voltage input, one supporting 0 ~ 10v voltage input or 4 ~ 20mA current input, 1 analog input terminal, supporting DC $\pm 10V$ or $\pm (4\sim 20mA)$
	Output terminals	1 high-speed pulse output terminal (optional open collector type), supporting square wave signal output of 0 ~ 100 khz 1 digital output terminal 1 relay output terminal 2 analog output terminals to support 0 ~ 20ma current output or 0 ~ 10v voltage output
Environment	Place of use	Dust - free, metal dust, corrosive gases, flammable gases, oil fog, salt fog, water vapor, dripping direct sunlight - free indoor
	Altitude	Below 1,000 meters
	Ambient temperature	-10°C ~ 40°C
	Humidity	Less than 90 % RH without condensation
	Vibration	Less than 0.5g.
	Storage temperature	-25°C ~ 65°C
	Protection grade	IP20

Appendix I general purpose keyboard dimensions and mounting dimensions

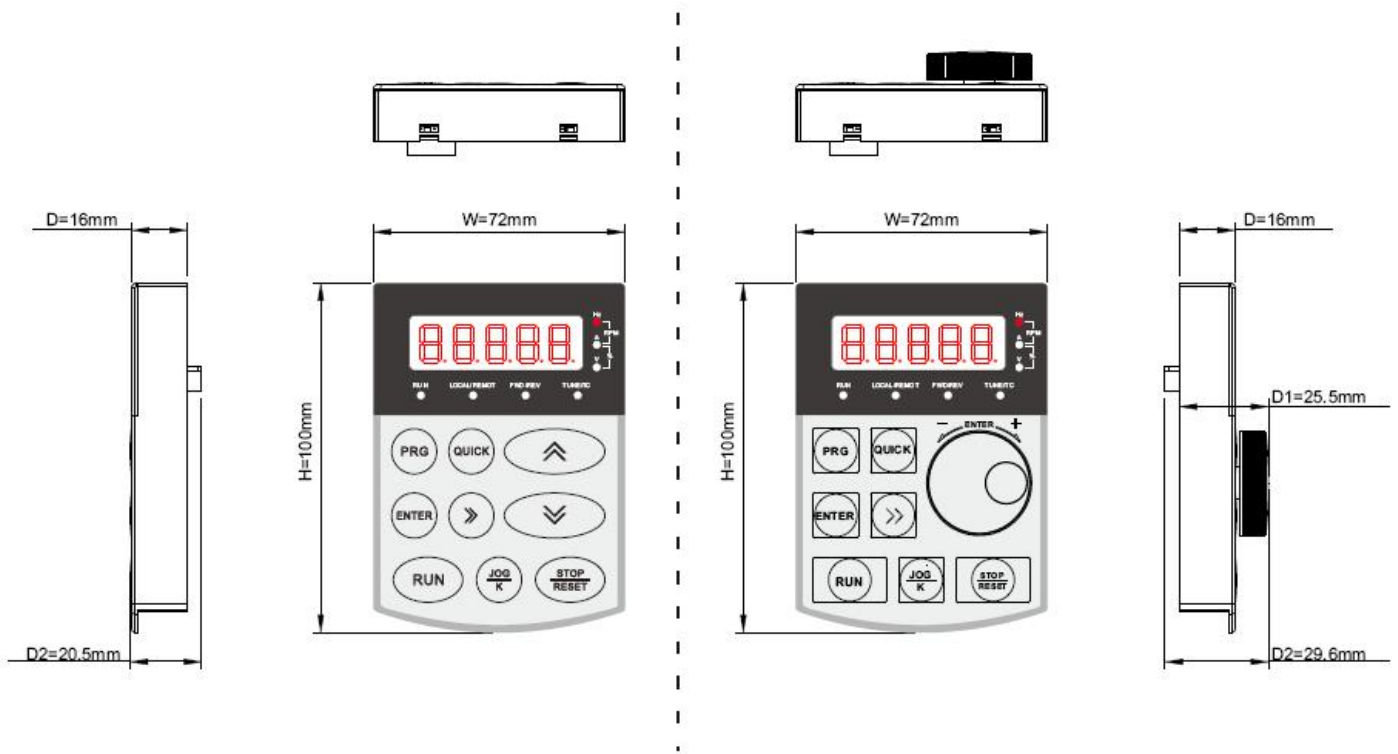

Fig A (keyboard operation in two ways)

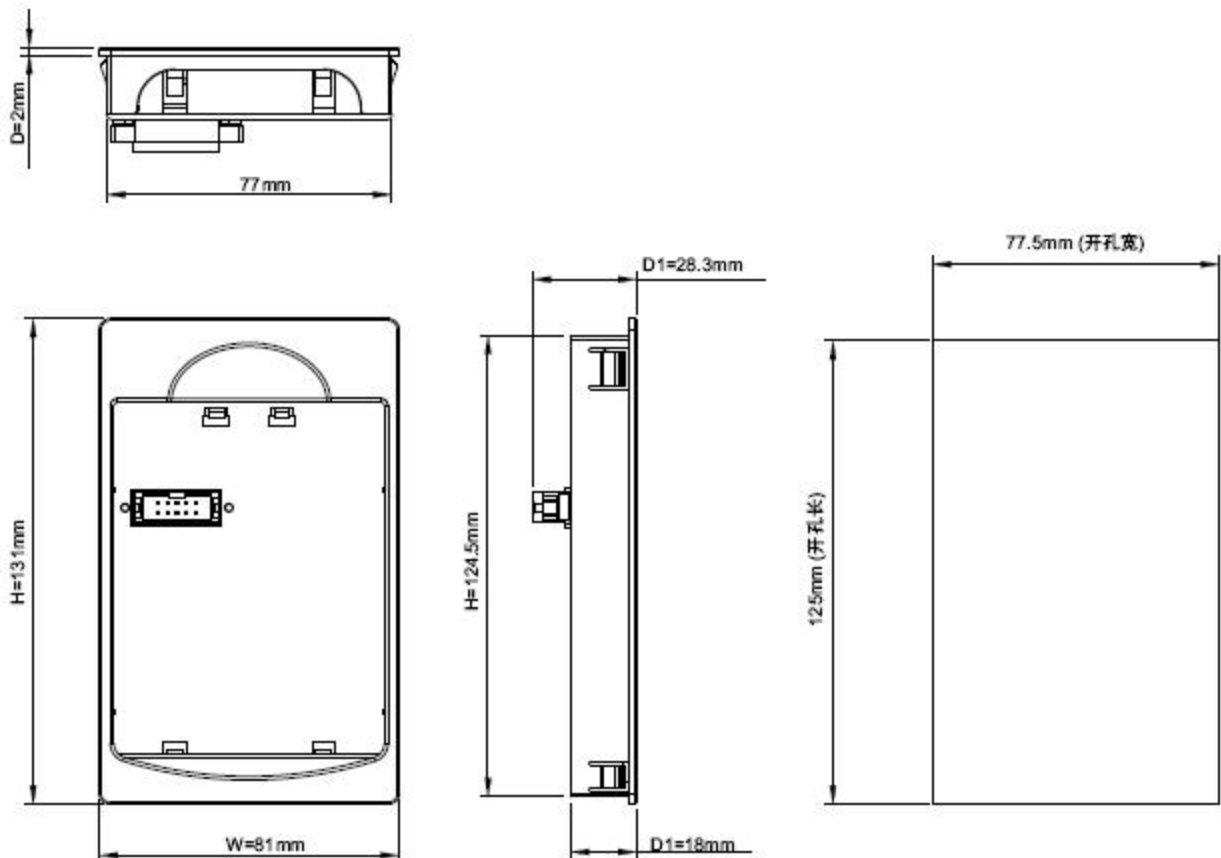

Fig. B (keyboard bracket and hole size drawing)

Appendix II Plastic shell dimensions and mounting dimensions

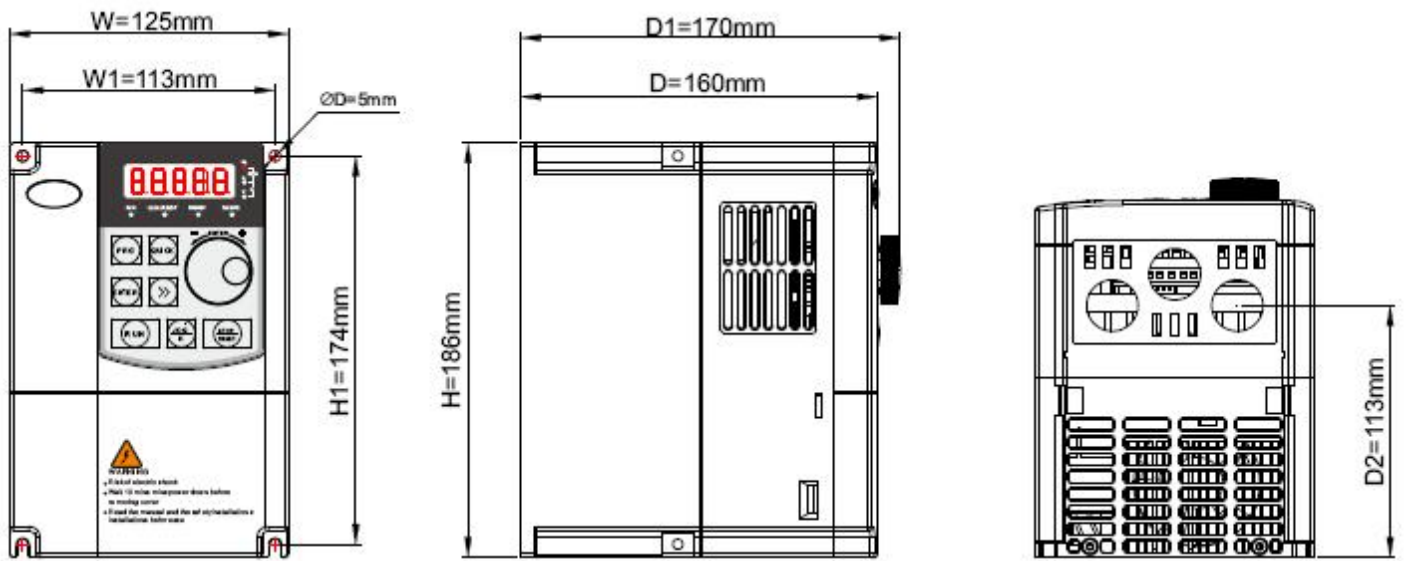

Fig 1(R75G3-2R2G3)

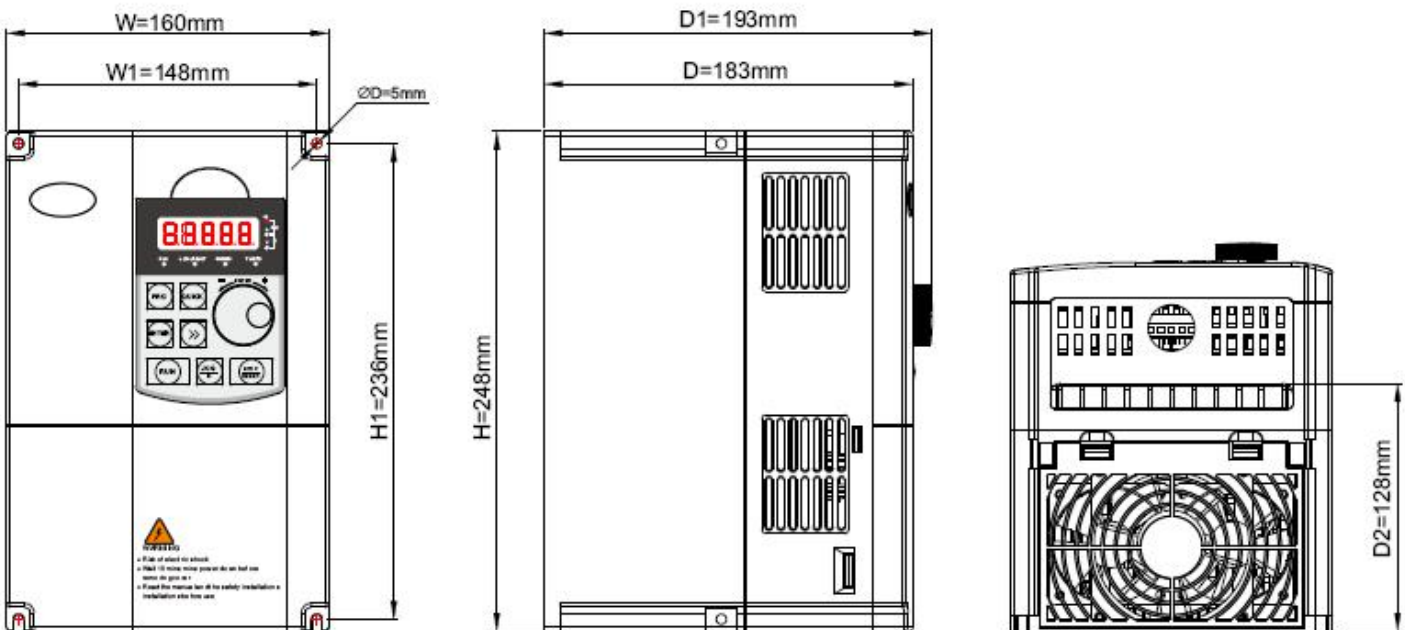

Fig 2(004G3-7R5G3)

Appendix III dimensions and mounting dimensions of sheet metal machines

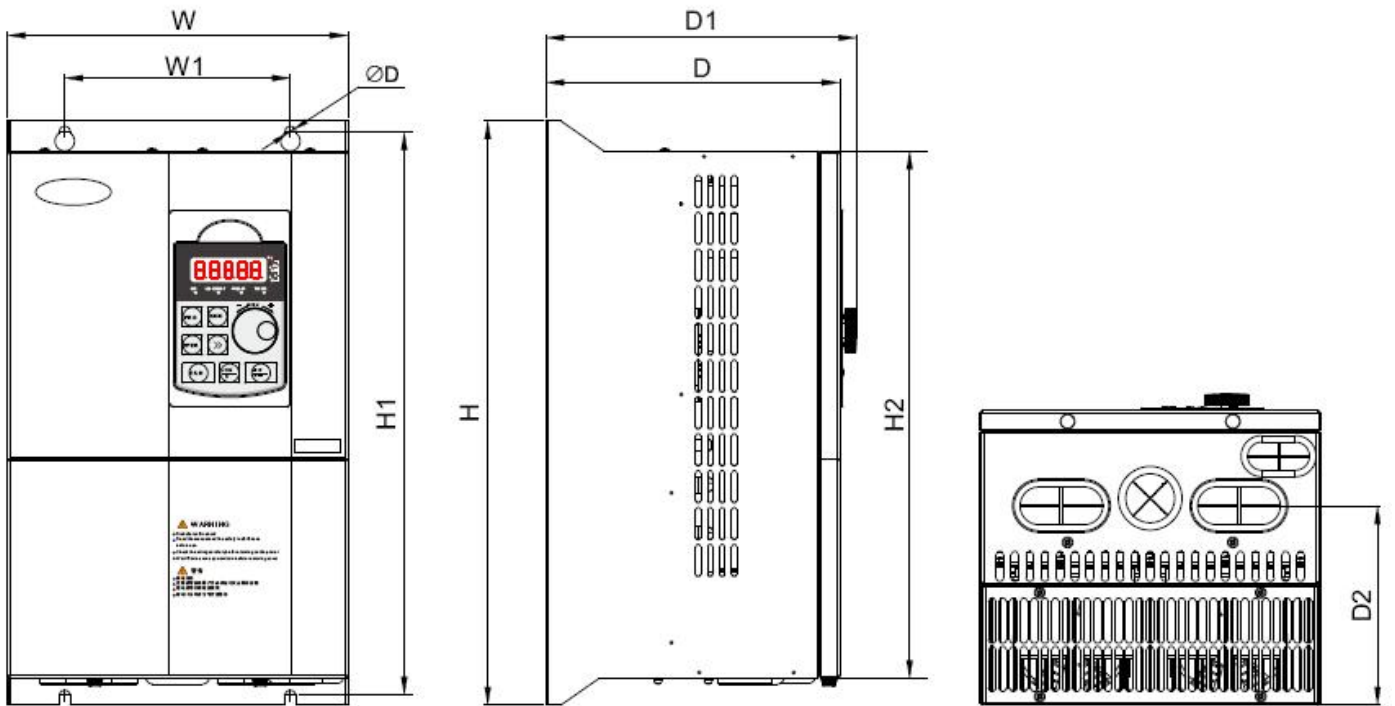

Fig 3(011G3-200G3)

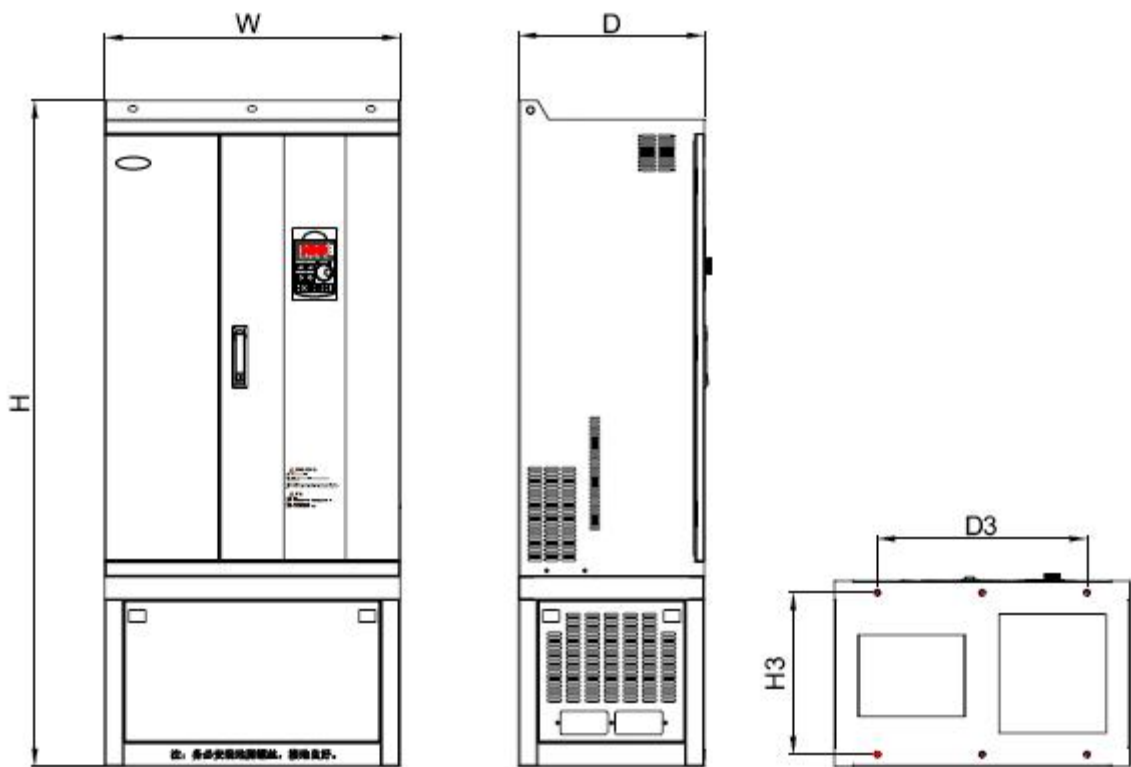

Fig 4(185G3-560G3)

List of dimensions and mounting dimensions

Model	External dimension (mm)			Installation hole location (mm)					Mounting aperture (mm)	Figure	N.W (kg)	G.W (kg)
	W	H	D	W1	H1	D1	H2	D2	d			
G1 input voltage range: Single-phase AC220V±15%, 50 / 60 Hz												
HV610-R75G1	101	152	117	89	140	128		84	5	1	1.6	2.1
HV610-1R5G1											1.6	2.1
HV610-2R2G1	125	220	166	110	205	177		124	6.5	1	3.5	4.2
G2 input voltage range: Three-phase AC220V±15%, 50 / 60 Hz												
HV610-R75G2	125	186	160	113	174	170	/	113	5	1	1.6	2.1
HV610-1R5G2											1.6	2.1
HV610-2R2G2	160	248	183	148	236	193	/	128	5	2	3.5	4.2
HV610-004G2											3.5	4.2
HV610-5R5G2	195	330	185	150	315	197	284	130	6	3	8.5	9.6
HV610-7R5G2											8.5	9.6
HV610-011G2	227	388	196	150	375	206	350	133	7	3	10	11
HV610-015G2	255	435	202	150	425	213	400	140	7	3	14	15
HV610-018G2											14	15
HV610-022G2	307	557	266	230	537	278	501	204	9	3	24	35
HV610-030G2											24	35
HV610-037G2	377	628	280	240	600	292	568	228	9	3	35	48
HV610-045G2											35	48
HV610-055G2											35	48
HV610-075G2	500	788	350	270	762	357	728	266	13	3	66	88
HV610-093G2	540	900	348	320	867	358	828	278	13	3	77	103
HV610-110G2											84	110
HV610-132G2	620	1035	390	500	1005	400	960	307	13	3	125	156
HV610-160G2	780	1290	400	600	1257	410	1203	316	13	3	185	235
HV610-185G2											185	235
HV610-200G2											185	235
HV610-220G2											185	235
G3 input voltage range: Three-phase AC 380~440 (-15%~+10%), 50 / 60 Hz												
HV610-R75G3	125	186	160	113	174	170	/	113	5	1	1.6	2.1
HV610-1R5G3											1.6	2.1
HV610-2R2G3											1.6	2.1
HV610-004G3	160	248	183	148	236	193	/	128	5	2	3.5	4.2
HV610-5R5G3											3.5	4.2
HV610-7R5G3											3.5	4.2

HV610-011G3	195	330	185	150	315	197	284	130	6	3	8.5	9.6
HV610-015G3											8.5	9.6
HV610-018G3	227	388	196	150	375	206	350	133	7	3	10	11
HV610-022G3											10	11
HV610-030G3	255	435	202	150	425	213	400	140	7	3	14	15
HV610-037G3											14	15
HV610-045G3	307	557	266	230	537	278	501	204	9	3	24	35
HV610-055G3											24	35
HV610-075G3	377	628	280	240	600	292	568	228	9	3	35	48
HV610-093G3											35	48
HV610-110G3											35	48
HV610-132G3	500	788	350	270	762	357	728	266	13	3	60	82
HV610-160G3											66	88
HV610-185G3	540	900	348	320	867	358	828	278	13	3	77	103
HV610-200G3										4	79	105
HV610-220G3											84	110
HV610-250G3	620	1035	390	500	1005	400	960	307	13	3	125	156
HV610-280G3	Cabinet machine (H x W x D): 1400x620x400 (H3=340mm D3=440mm)									4	125	156
HV610-315G3	780	1290	400	600	1257	410	1203	316	13	3	185	235
HV610-355G3										4	185	235
HV610-400G3											185	235
HV610-450G3	1750	950	460	H3=320mm	D3=820mm	4						
HV610-500G3												
HV610-560G3												
HV610-630G3												
G4 input voltage range: Three-phase AC 460~480 (-15%~+10%), 50 / 60 Hz												
HV610-R75G4	125	186	160	113	174	170	/	113	5	1	1.6	2.1
HV610-1R5G4											1.6	2.1
HV610-2R2G4											1.6	2.1
HV610-004G4	160	248	183	148	236	193	/	128	5	2	3.5	4.2
HV610-5R5G4											3.5	4.2
HV610-7R5G4											3.5	4.2
HV610-011G4	195	330	185	150	315	197	284	130	6	3	8.5	9.6
HV610-015G4											8.5	9.6
HV610-018G4	227	388	196	150	375	206	350	133	7	3	10	11
HV610-022G4											10	11
HV610-030G4	255	435	202	150	425	213	400	140	7	3	14	15
HV610-037G4											14	15

HV610-045G4	307	557	266	230	537	278	501	204	9	3	24	35											
HV610-055G4											24	35											
HV610-075G4	377	628	280	240	600	292	568	228	9	3	35	48											
HV610-093G4											35	48											
HV610-110G4											35	48											
HV610-132G4	500	788	350	270	762	357	728	266	13	3	60	82											
HV610-160G4											66	88											
HV610-185G4	540	900	348	320	867	358	828	278	13	3	77	103											
HV610-200G4											Cabinet machine (H x W x D): 11268x540x358 (H3=266mm D3=440mm)										4	79	105
HV610-220G4																					84	110	
HV610-250G4	620	1035	123	155	1005	400	960	307	13	3	125	156											
HV610-280G4											Cabinet machine (H x W x D): 1400x620x400 (H3=340mm D3=440mm)										4	125	156
HV610-315G4	780	1290	185	235	1257	410	1203	316	13	3	185	235											
HV610-355G4											Cabinet machine (H x W x D): 1650x780x410 (H3=340mm D3=600mm)										4	185	235
HV610-400G4																					185	235	
HV610-450G4											4												
HV610-500G4														Cabinet machine (H x W x D): 1750x950x460 (H3=320mm D3=820mm)									
HV610-560G4																							
HV610-630G4																							

Appendix D HV610 series inverter specifications

Frequency inverter model	Input current (A)	Output current(A)	Adaptive motor (KW)	(HP)	Power supply capacity (KVA)
G1 input voltage range: Single-phase AC220V \pm 15%, 50 / 60 Hz					
HV610-R75G1	11.0	4.0	0.75	1	3.0
HV610-1R5G1	18.0	7.0	1.5	2	4.8
HV610-2R2G1	27.0	9.6	2.2	3	7.1
G2 input voltage range: Three-phase AC220V \pm 15%, 50 / 60 Hz					
HV610-R75G2	5	3.8	0.75	1	3
HV610-1R5G2	5.8	5.1	1.5	2	4.0
HV610-2R2G2	10.5	9.0	2.2	3	5.9
HV610-004G2	14.6	13.0	3.7	5	8.9
HV610-5R5G2	26.0	25.0	5.5	7.5	17
HV610-7R5G2	35.0	32.0	7.5	10	21
HV610-011G2	46.5	45	11	15	30
HV610-015G2	62	60	15	20	40
HV610-018G2	76	75	18	25	57
HV610-022G2	92	91	22	30	69
HV610-030G2	113	112	30	40	85
HV610-037G2	157	150	37	50	114
HV610-045G2	180	176	45	60	134
HV610-055G2	214	210	55	75	160
HV610-075G2	307	304	75	100	231
HV610-093G2	385	377	90	125	250
HV610-110G2	430	426	110	150	280
HV610-132G2	525	520	132	175	396
HV610-160G2	665	650	160	220	500
HV610-185G2	735	725	185	245	560
HV610-200G2	835	820	200	270	630
HV610-220G2	925	910	220	300	700
G3 input voltage range: Three-phase AC 380~440 (-15%~+10%), 50 / 60 Hz					
HV610-R75G3	3.4	2.1	0.75	1	1.5
HV610-1R5G3	5.0	3.8	1.5	2	3.0
HV610-2R2G3	5.8	5.1	2.2	3	4.0
HV610-004G3	10.5	9.0	4.0	5	5.9
HV610-5R5G3	14.6	13.0	5.5	7.5	8.9
HV610-7R5G3	20.5	17.0	7.5	10	11

HV610-011G3	26.0	25.0	11	15	17
HV610-015G3	35.0	32.0	15	20	21
HV610-018G3	42	37	18.5	25	45
HV610-022G3	50	45	22	30	54
HV610-030G3	68	60	30	40	60
HV610-037G3	83	75	37	50	63
HV610-045G3	102	91	45	60	81
HV610-055G3	124	112	55	75	97
HV610-075G3	169	150	75	100	127
HV610-093G3	203	176	90	125	150
HV610-110G3	248	210	110	150	179
HV610-132G3	256	253	132	175	192
HV610-160G3	307	304	160	220	231
HV610-185G3	350	340	185	245	242
HV610-200G3	385	377	200	270	250
HV610-220G3	430	426	220	300	280
HV610-250G3	468	465	250	340	355
HV610-280G3	525	520	280	380	396
HV610-315G3	590	585	315	430	445
HV610-355G3	665	650	355	420	500
HV610-400G3	785	725	400	530	565
HV610-450G3	883	820	450	600	630
HV610-500G3	954	920	500	670	720
HV610-560G3	1085	1030	560	750	780
HV610-630G3	1184	1100	630	840	800
G4 input voltage range: Three-phase AC 460~480 (-15%~+10%), 50 / 60 Hz					
HV610-R75G4	3.4	2.1	0.75	1	1.5
HV610-1R5G4	5.0	3.8	1.5	2	3.0
HV610-2R2G4	5.8	5.1	2.2	3	4.0
HV610-004G4	10.5	9.0	4.0	5	5.9
HV610-5R5G4	14.6	13.0	5.5	7.5	8.9
HV610-7R5G4	20.5	17.0	7.5	10	11
HV610-011G4	26.0	25.0	11	15	17
HV610-015G4	35.0	32.0	15	20	21
HV610-018G4	42	37	18.5	25	45
HV610-022G4	50	45	22	30	54
HV610-030G4	68	60	30	40	60
HV610-037G4	83	75	37	50	63
HV610-045G4	102	91	45	60	81
HV610-055G4	124	112	55	75	97

HV610-075G4	169	150	75	100	127
HV610-093G4	203	176	90	125	150
HV610-110G4	248	210	110	150	179
HV610-132G4	256	253	132	175	192
HV610-160G4	307	304	160	220	231
HV610-185G4	350	340	185	245	242
HV610-200G4	385	377	200	270	250
HV610-220G4	430	426	220	300	280
HV610-250G4	468	465	250	340	355
HV610-280G4	525	520	280	380	396
HV610-315G4	590	585	315	430	445
HV610-355G4	665	650	355	420	500
HV610-400G4	785	725	400	530	565
HV610-450G4	883	820	450	600	630
HV610-500G4	954	920	500	670	720
HV610-560G4	1085	1030	560	750	780
HV610-630G4	1184	1100	630	840	800

Constant pressure control solution Case V0.1 for water pump and fan

1.1. Overview

The process PID closed-loop control regulates the rotation speed of the motor and indirectly controls the water pressure or air pressure of the pipeline to be constant.

2.1 Two types of pressure sensors for pump and fan control

Type 1: 0 ~ 10v remote pressure gauge

Type 2: 4 ~ 20ma pressure transmitter

3.1 Control wiring diagram

Type 1: pressure sensor is 0 ~ 10v remote pressure gauge

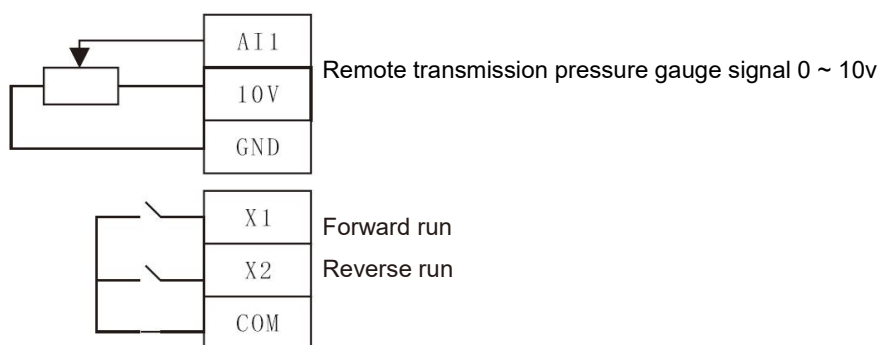

Type 2: the pressure sensor is a 4 ~ 20mA

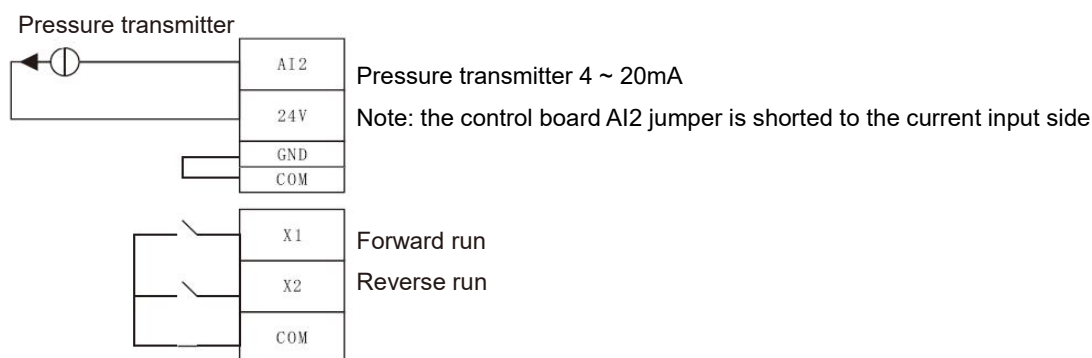

3.2 Setting parameters

Type 1: 0 ~ 10v remote transmission pressure gauge

Name	Function code	Numerical	Description
Control mode	F0-01	2	V/F control
Main frequency source	F0-03	8	PID constant pressure water supply
PID given source	FA-00	0	Pressure setting is set by FA - 01 parameter

PID value given	FA-01	25%	The set pressure is 2.5kg.
PID feedback source	FA-02	0	The pressure gauge is fed back to AI1 (0 ~ 10v input)
Name	Function code	Numerical	Description
PID feedback range	FA-04	1000	The measuring range of pressure gauge is 10kg
Proportional gain	FA-05	30	
Integration time	FA-06	1	
Selection of PID shutdown operation	FA-28	1	Continue calculation when shutdown
Stress wake-up option	FA-29	1	Pressure wake-up is valid during sleep
Percentage of wake-up pressure	FA-30	80%	It will be awakened when pipeline pressure is lower than $2.5 * 80 \% = 2\text{kg}$
Wake - up delay time	FA-31	1s	
Percentage of dormant pressure	FA-32	100%	When the pipeline pressure is greater than the set pressure of 2.5kg, it goes to sleep after 60s.
Pressure sleep delay time	FA-33	60s	

Type 2: The 4 ~ 20ma pressure transmitter

Modifies the following parameters based on the type 1 parameters, and the control board AI2 jumper is shorted to the current input side

Name	Function code	Numerical	Description
AI2 minimum input	F5-29	2.00	2v correspond to 4mA
PID feedback source	FA-02	1	The feedback source is AI2 (4 ~ 20ma current signal)

4.1 The sleep wake-up function

Has two sleep modes. During the control process, one of them can be selected according to actual needs.

1) Sleep according to pressure, that is, after the pressure reaches the sleep pressure threshold, the frequency inverter stops outputting after a delay time.

Stress wake-up option	FA-29	1	Pressure wake-up is valid during sleep
Percentage of wake-up pressure	FA-30	80%	It will be awakened when pipeline pressure is lower than $2.5 * 80 \% = 2\text{kg}$
Wake - up delay time	FA-31	1s	
Percentage of dormant pressure	FA-32	100%	When the pipeline pressure is greater than the set pressure of 2.5kg, it goes to sleep after 60s.

2) Sleep according to the frequency, that is, the frequency is lower than the sleep frequency threshold. After the delay time, the frequency inverter stops outputting.

Stress wake-up option	FA-29	0	Pressure wake-up is invalid during sleep (according to wake-up frequency)
Wakeup frequency	F8-14	40hz	When the set frequency is greater than 40hz, the frequency inverter wakes up
Wake - up delay time	F8-15	1s	
Sleep frequency	F8-16	25hz	When the set frequency is lower than 25hz, enter the sleep state after 60 seconds between F8 and 17 hours

3) No need to sleep

Stress wake-up option	FA-29	0	Pressure wake-up is invalid during sleep
Wakeup frequency	F8-14	0	
Wake - up delay time	F8-15	0	
Sleep frequency	F8-16	0	

Inquiry method of state parameters

In the shutdown or running state, the >> shift key ON the operation panel switches the contents corresponding to each byte of the function code F0 - 37 / 38 / 39 and can display multiple status parameters. There are 32 operating state parameters in the operating state, and the function code F0 - 37 / 38 selects whether each corresponding parameter is displayed according to the binary bit.

There are 13 shutdown state parameters under shutdown state, and the functional codes F0 - 39 select whether each corresponding parameter is displayed according to the binary bit.

Correspondence between decimal system and hexadecimal system:

Decimal system	0123456789	10	11	12	13	14	15
Hexadecimal	0123456789	A	B	C	D	E	F

Examples:

Check the parameters in the running state through the panel: (running frequency, bus voltage, output voltage, output current, Output power, PID setting).

1. According to the correspondence between each byte in the function code F0 - 37 and the above parameters, the corresponding bit is set to 1.
2. Set this binary number to F0 - 37 after converting it to hexadecimal. Keyboard setting value: h 001f.
3. Use the >> key on the operation panel to switch the corresponding contents of each byte of the function code F0 - 37 in turn, and you can check the values of relevant parameters. Set as shown in the figure below:

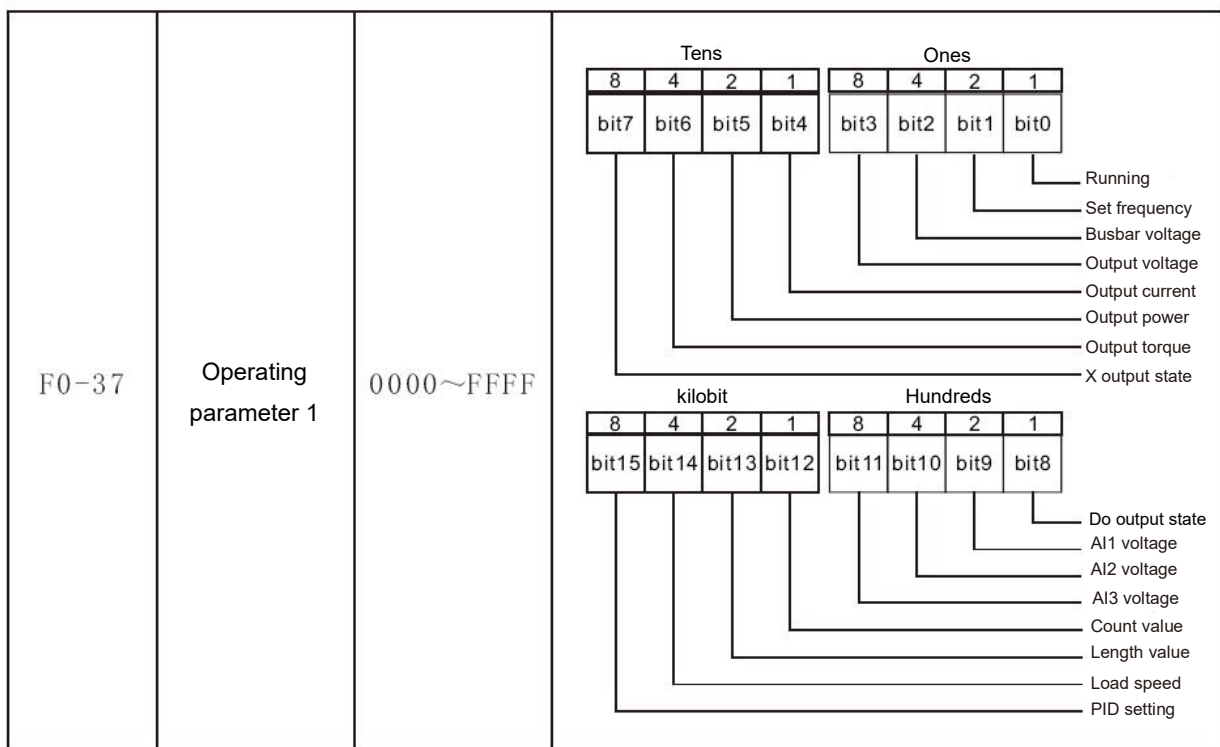
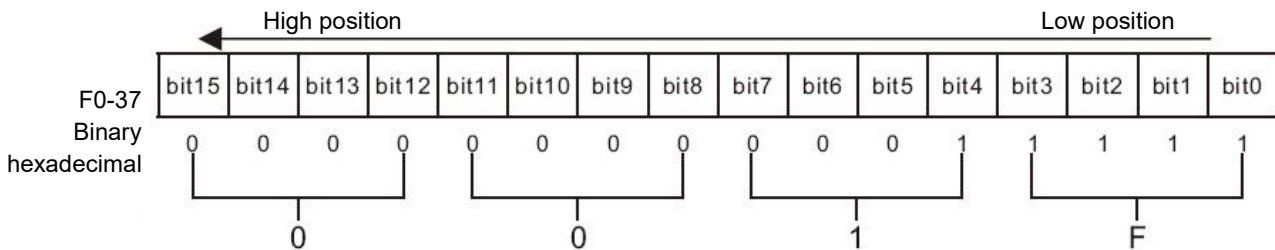

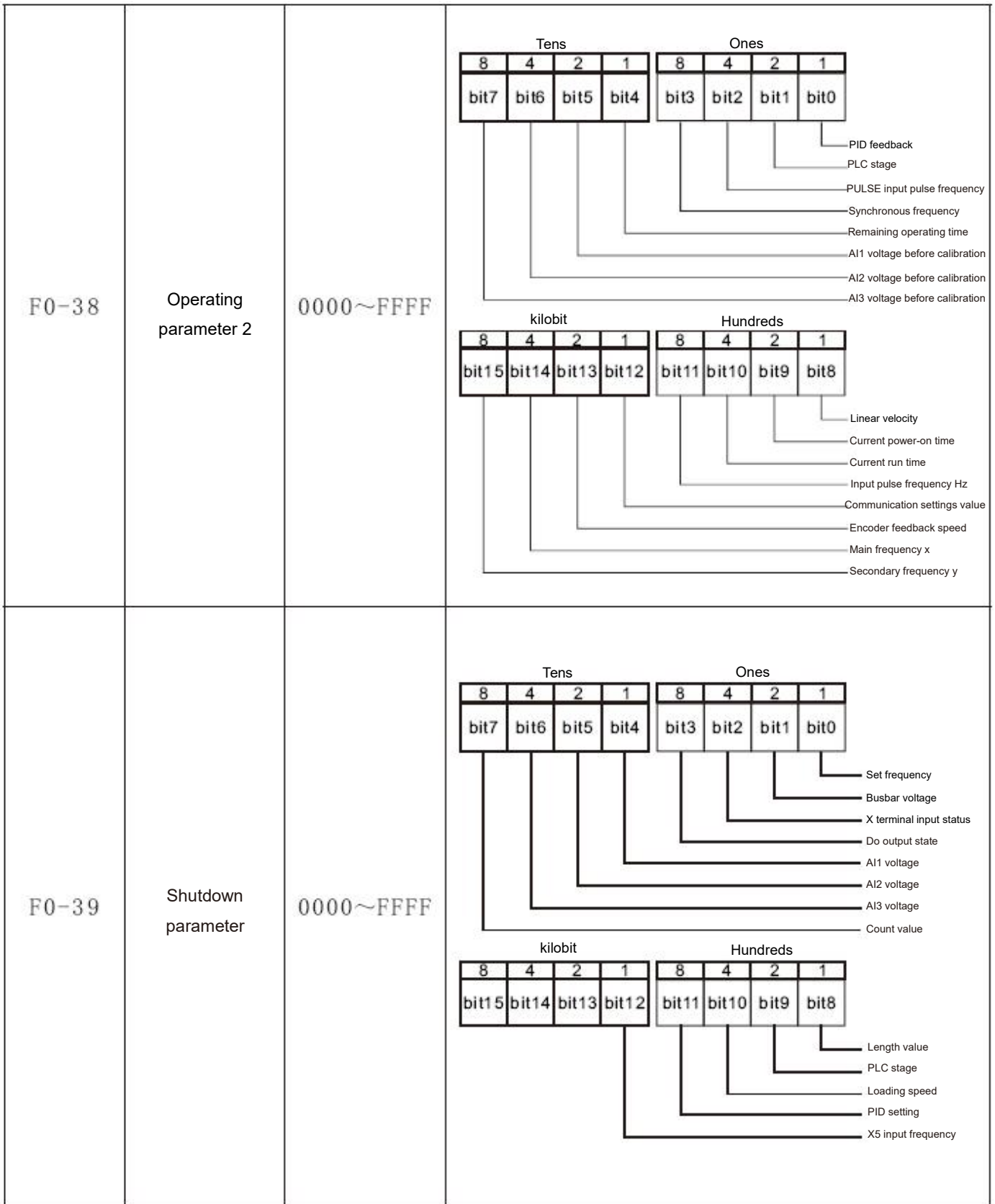

Warranty Agreement

1. The warranty period of the product is 18 months (refer to the barcode on the equipment). During the warranty period, if the product fails or is damaged under the condition of normal use by following the instructions, HNC Electric will be responsible for free maintenance.
2. Within the warranty period, maintenance will be charged for the damages caused by the following reasons:
 - a. Improper use or repair/modification without prior permission
 - b. Fire, flood, abnormal voltage, other disasters and secondary disaster
 - c. Hardware damage caused by dropping or transportation after procurement
 - d. Improper operation
 - e. Trouble out of the equipment (for example, external device)
3. If there is any failure or damage to the product, please correctly fill out the Product Warranty Card in detail.
4. The maintenance fee is charged according to the latest Maintenance Price List of HNC Electric.
5. The Product Warranty Card is not re-issued. Please keep the card and present it to the maintenance personnel when asking for maintenance.
6. If there is any problem during the service, contact HNC Electric's agent or HNC Electric directly.
7. This agreement shall be interpreted by HNC Electric Limited.

Thanks for choosing HNC product.

Any technique support, please feel free to contact our support team

Tel: 86(20)84898493 Fax: 86(20)61082610

URL: www.hncelectric.com

Email: support@hncelectric.com

